

IPA FITTINGS

FOR 16 X 5 MM GROOVE

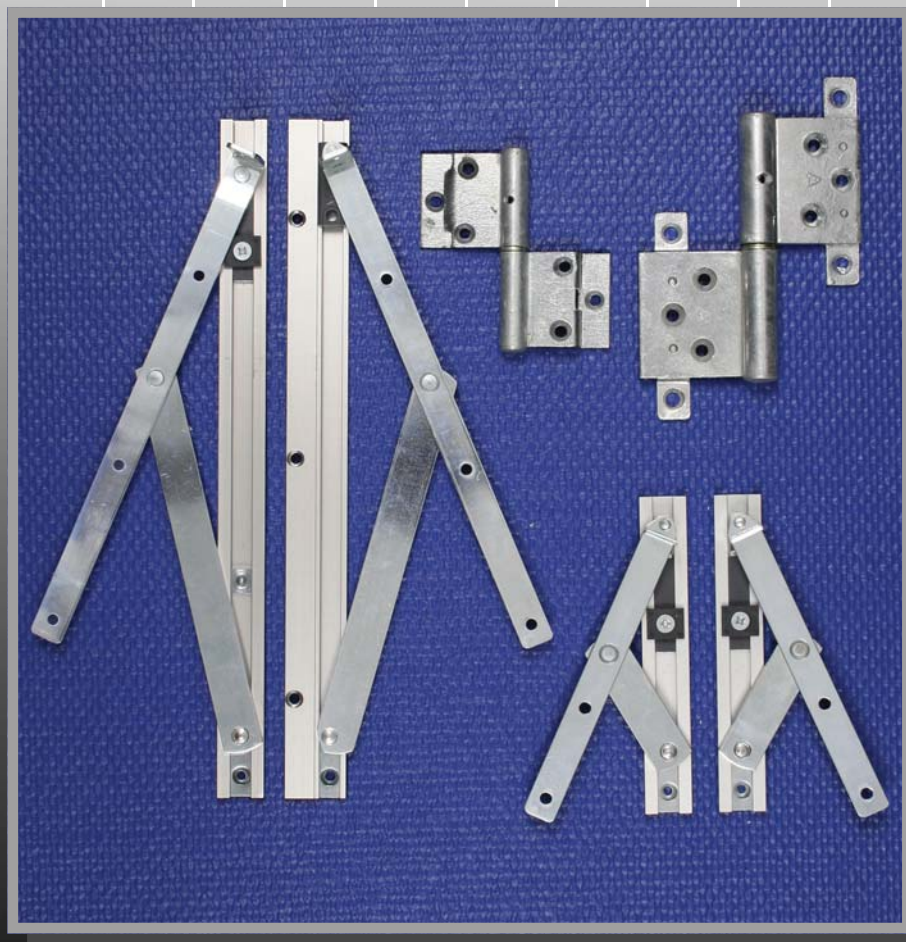

2019



A/S J. PETERSENS BESLAGFABRIK

JACOB PETERSENSVEJ 9, DK-9240 NIBE

TEL: (+45) 98 35 15 00





FITTINGS FOR 16 X 5 GROOVE

Table of Contents

	<u>PAGE</u>
Wood profile	4
Suggestion - Number of Hinges	5
Suggestion - Hinge Positions	6
 <u>FITTINGS</u>	
IPA No.s 61507 - 08	Door hinge for top mounting 7
IPA No.s 61567 + 74 + 78	Window hinge 8
IPA No.s 61597-98	Door hinge 9 - 10
IPA No. 62595	Side swing window 90° with friction 11 - 12
IPA No.s 62506 - 12	Top swing fitting 13 - 14
IPA No. 62562	Safety Restrictor 13 - 14
IPA No. 62155	Threated plate 13
IPA No.s 62570 - 75	Canopy Stays 15 - 16
IPA No.s 62586 - 87 + 89	Adjustable Canopy Stays with friction 17 - 18
IPA No. 62588	Adjustable Canopy Stays with Adjustable Friction 19 - 20
IPA No. 62536	Safety Catch 21 - 22
IPA No. 62527	Friction Stay for windows 23
IPA No. 63511	Friction Stay for doors 24
IPA No. 62222 + 63230 + 35	Support Fitting + Guide Block 25
IPA No.s 63508 - 09	Flush Bolt 25
IPA No.s 21311 - 13	Casement Stays 26
IPA No. 21343 - 57	Casement Hooks 26
IPA No. 21359	Catch for Casement Hooks 27
IPA No. 21360	Holder for Casement Hooks 27
IPA No.s 21361 - 63 + 69	Hook Catch + Nails 27
IPA No.s 21381 - 82	Hook Catch 27
IPA No. 21376	Casement Fasteners 28
IPA No.s 21370 - 73	Casement Hook 28 - 29
IPA No.s 21378 - 79	Casement Hooks with 2 holes 28 - 29
IPA No.s 21383 - 96 + 21593-94	Casement Fasteners 30 - 31
IPA No.s 23228 - 38	Handles and Safety lock 32
IPA No.s 23269 - 70 + 63252	Receivers 32
IPA No.s 23601 - 09 + 23615 - 24	Espagnolettes 33 - 34
IPA No.s 63021 - 30 + 63041 - 50	Espagnolettes 35 - 36
IPA No.s 63051 - 60 + 63081	Espagnolettes and guide pin 37 - 38
IPA No. 23190	Receiver 37 - 38
	Lubrication Instructions 39 - 40



16 X 5 MM GROOVE

Example Wood Profile

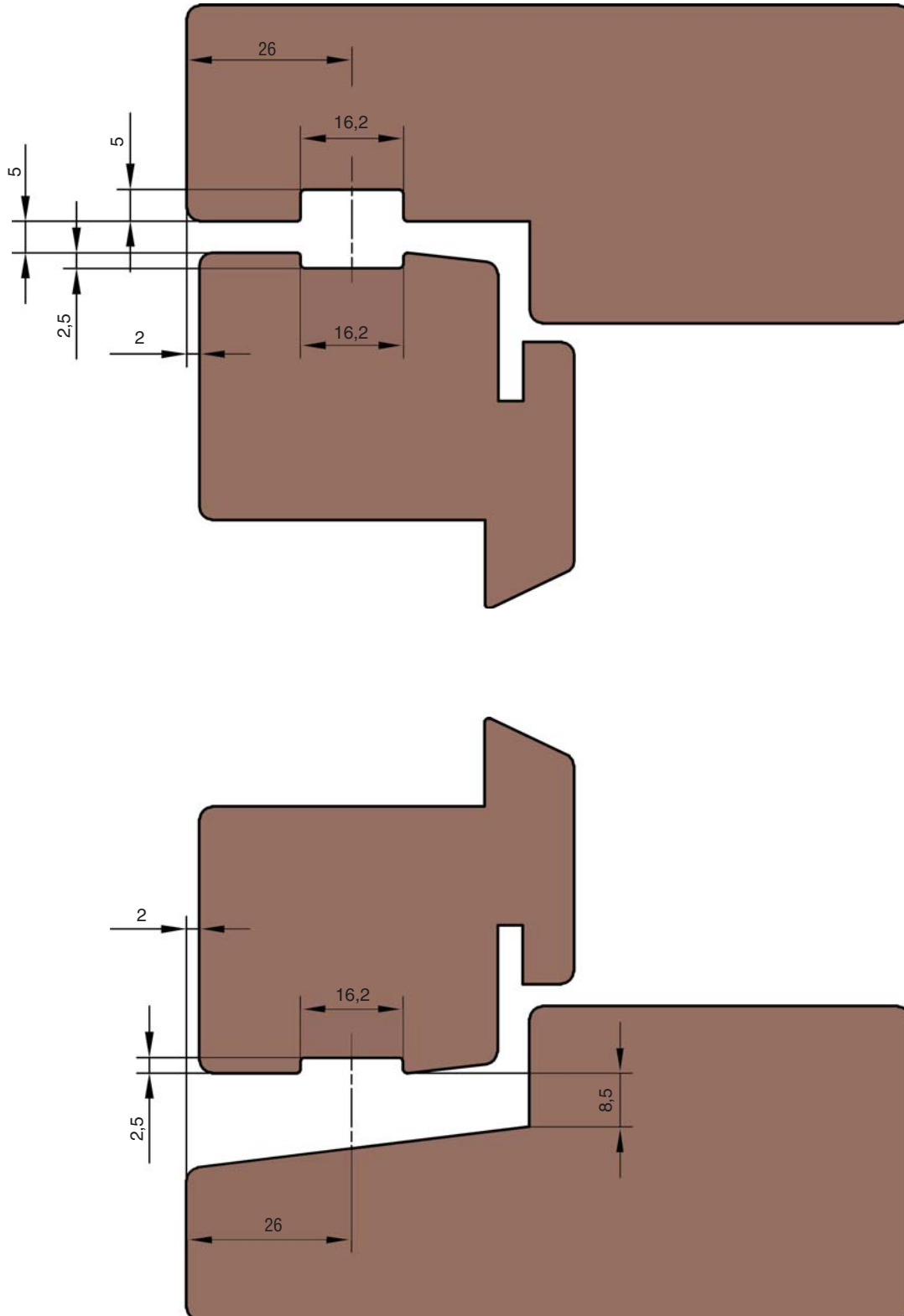



SUGGESTION - NUMBER OF HINGES

The charts below show the number of hinges, we suggest to use on different sizes of windows and doors. The charts shall ONLY be considered as a guidance, as the number of hinges also will depend on the use and weight of the window/door. If the window/door is mounted in a public building with many users (Schools, Railway Stations etc.) then more or even larger hinges are recommended.

Also we suggest to use a support fitting whenever possible.

WINDOW HINGES: Valid for the window hinges shown in this catalogue.

All window hinges meets the requirements of class 9 (60 Kgs.) in accordance with DS/EN 1935. The numbers in brackets are number of hinges in windows with 3-layer glass.

Width \ Height	< 500	501 - 600	601 - 700	701 - 800
1401 - 1500	2 (3)	3 (3)	3 (3)	3 (4)
1301 - 1400	2 (3)	3 (3)	3 (3)	3 (4)
1201 - 1300	2 (3)	3 (3)	3 (3)	3 (4)
1101 - 1200	2 (3)	3 (3)	3 (3)	3 (4)
1001 - 1100	2 (3)	3 (3)	3 (3)	3 (3)
901 - 1000	2 (2)	2 (2)	2 (2)	3 (3)
801 - 900	2 (2)	2 (2)	2 (2)	3 (3)
701 - 800	2 (2)	2 (2)	2 (2)	3 (3)
601 - 700	2 (2)	2 (2)	2 (2)	
501 - 600	2 (2)	2 (2)		
< 500	2 (2)			

DOORHINGES: Valid for door hinges shown in this catalogue.

All door hinges with steel pin meets the requirements of class 13 (120 Kgs.) in accordance with DS/EN 1935. The same hinges with brass pin meets the requirements of class 11 (80 Kgs.) in accordance with DS/EN 1935

Width \ Height	< 700	701 - 800	801 - 900	901 - 1000	1001 - 1100
2501 - 2600	5	5	5		
2401 - 2500	5	5	5	5	
2301 - 2400	4	4	4	5	5
2201 - 2300	4	4	4	4	5
2101 - 2200	3	3	3	4	4
2001 - 2100	3	3	3	3	4
< 2000	3	3	3	3	4



SUGGESTION - HINGE POSITIONS

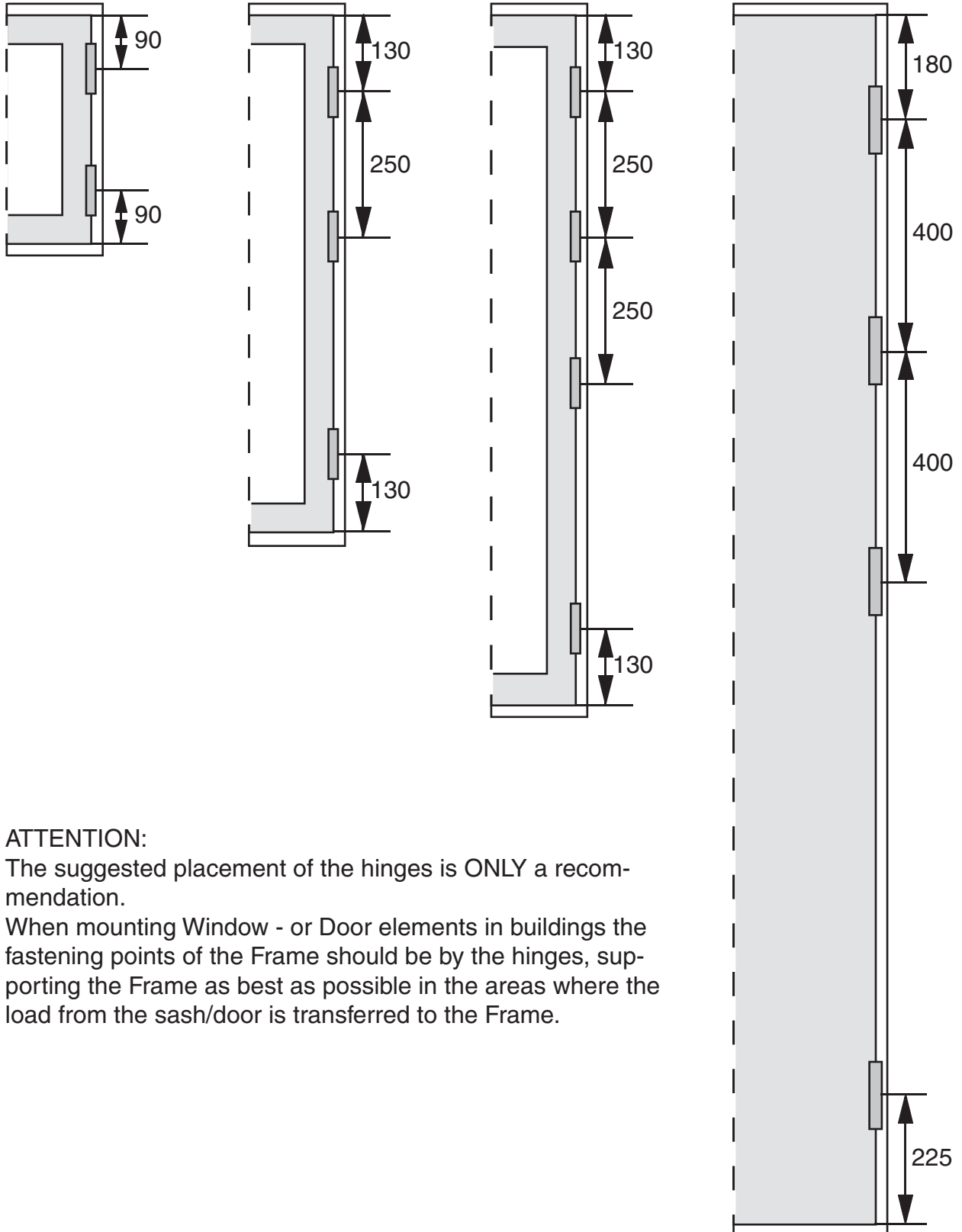

ATTENTION:

The suggested placement of the hinges is **ONLY** a recommendation.

When mounting Window - or Door elements in buildings the fastening points of the Frame should be by the hinges, supporting the Frame as best as possible in the areas where the load from the sash/door is transferred to the Frame.



DOORHINGE FOR TOP MOUNTING

IPA NO.s 61507-08

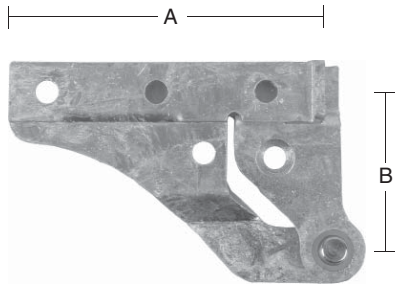
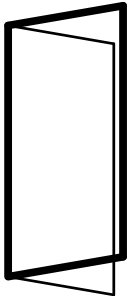

61508
LEFT

		ORDERING NO.								
IPA NO.	MATERIAL	LEFT	RIGHT	SURFACE	STANDARD PACKING IN BOXES OF 10 PCS.	A MM	B MM	MATERIAL MM	SCREW	APPROX. WEIGHT KGS / PC.
	STEEL			GALVANIZED						
61507	1	7	8	87	1	83	54,5	2,5	4,0	0,14
61508	1	7	8	87	1	83	41,5	2,5	4,0	0,11



IPA NO.s 61507-08

FITTING INSTRUCTIONS

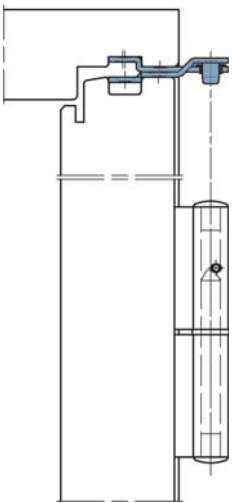

FIG. 1

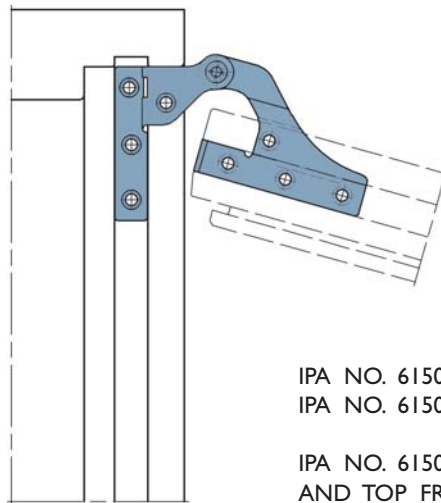

FIG. 2

IPA NO. 61507 IS TO BE USED TOGETHER WITH IPA NO. 61597
 IPA NO. 61508 IS TO BE USED TOGETHER WITH IPA NO. 61598

IPA NO. 61507-08 IS MOUNTED ON HINGE SIDE ON TOP SASH
 AND TOP FRAME AS SHOWN ON FIG. 1 AND FIG. 2

MAINTENANCE:

DO NOT PAINT THE FITTING.

WHEN FITTING - LUBRICATE THE MOVABLE METAL PARTS OF THE MECHANISM WHILE
 ACTIVATING REPEATEDLY. HEREAFTER LUBRICATE MINIMUM TWICE A YEAR.

SEE ALSO INSTRUCTIONS ON PAGE 41 - 42.



WINDOW HINGE

IPA NO.s 61567 + 61574 & 61578

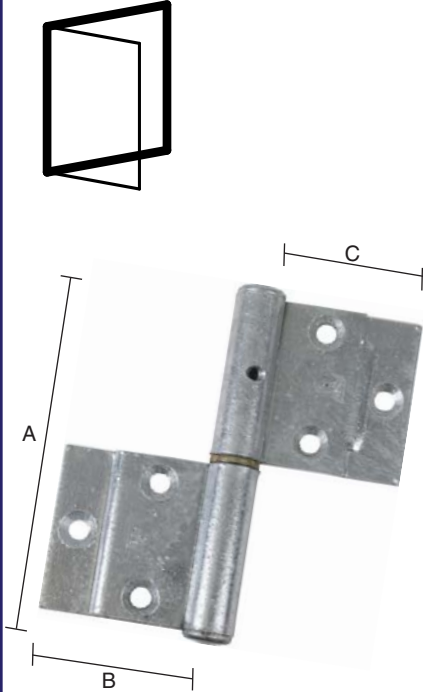

ORDERING NO.																
IPA NO.	MATERIAL				SURFACE					A MM	B MM	C MM	MATERIAL MM	PIN MM	SCREW	APPROX. WEIGHT KG./PC.
	STEEL FIXED STEEL PIN	STEEL FIXED BRASS PIN	SQUARE EDGES LEFT	SQUARE EDGES RIGHT	ELECTROPLATED/GEEY	ELECTROPLATED/WHITE	GALVANIZED	STANDARD PACKING IN BOXES OF 10 PIECES	INDUSTRY PACKING IN BOXES OF 100 PIECES							
61567	2	-	3	4	-	-	87	-	2	90	51,5	51,5	2,8	8	4,0	0,17
	2	-	3	4	64	-	87	-	2	90	38,5	38,5	2,5	8	4,0	0,17
61574	-	3	3	4	-	-	87	-	2	90	38,5	38,5	2,5	8	4,0	0,17
	-	3	3	4	-	-	87	-	2	90	38,5	38,5	2,5	8	4,0	0,17
61578	-	3	3	4	-	-	87	-	2	90	38,5	38,5	2,5	8	4,0	0,17
	-	3	3	4	-	06	-	1	-	90	38,5	38,5	2,5	8	4,0	0,17



IPA NO.s 61567 + 61574 & 61578 FITTING INSTRUCTIONS

EXAMPLE - WOOD PROFILE:

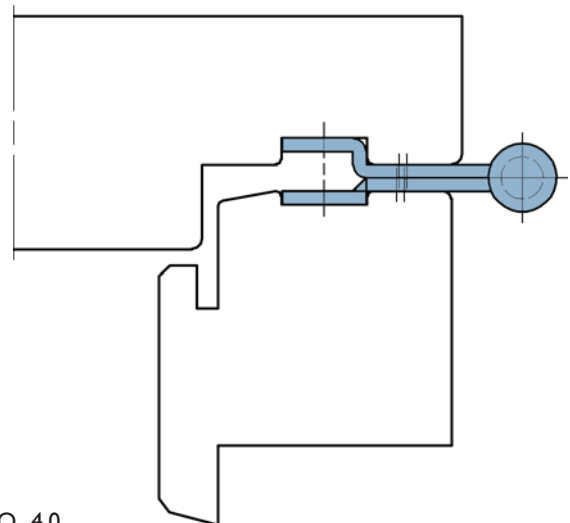
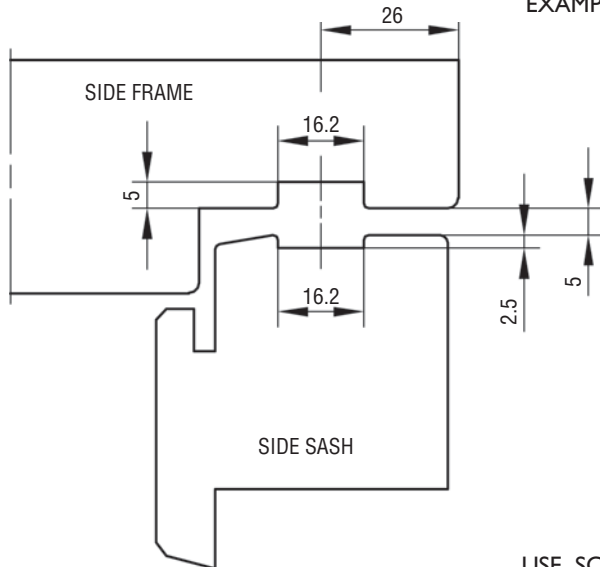

USE SCREW NO. 4.0.

MAINTENANCE:

TEST THE OPERATION FROM TIME TO TIME. WHEN FITTING - GREASE THE PIVOT/MOVABLE METAL PARTS OF THE MECHANISM WHILE ACTIVATING REPEATEDLY. HEREAFTER GREASE MINIMUM TWICE A YEAR. SEE ALSO INSTRUCTIONS ON PAGE 41 - 42.



DOORHINGE

IPA NO.s 61597-98

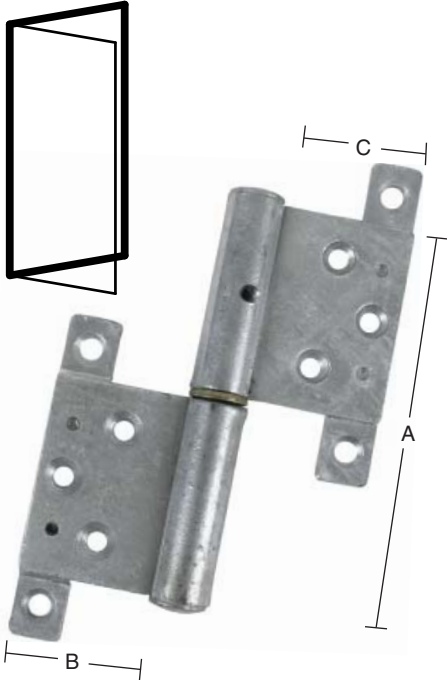

IPA NO.	MATERIAL		SURFACE		STANDARD PACKING IN BOXES OF 50 PCS.	A MM	B MM	C MM	MATERIAL MM	PIN MM	SCREW	APPROX. WEIGHT KGS / PC.		
	STEEL FIXED STEEL PIN	STEEL FIXED BRASS PIN	SAUARE EDGES LEFT	SAUARE EDGES RIGHT									ELECTROPLATED/GREY	GALVANIZED
	ORDERING NO.													
61597	2	-	3	4	-	87	2	120	54	54	4,0	9,5	5,0	0,48
61598	2	-	3	4	64	87	2	120	41	41	4,0	9,5	5,0	0,43
	-	3	3	4	-	87	2							



IPA NO.s 61597-98

FITTING INSTRUCTIONS

EXAMPLE - WOOD PROFILE:

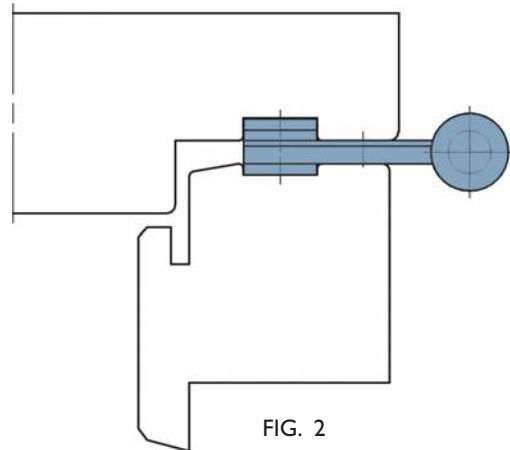
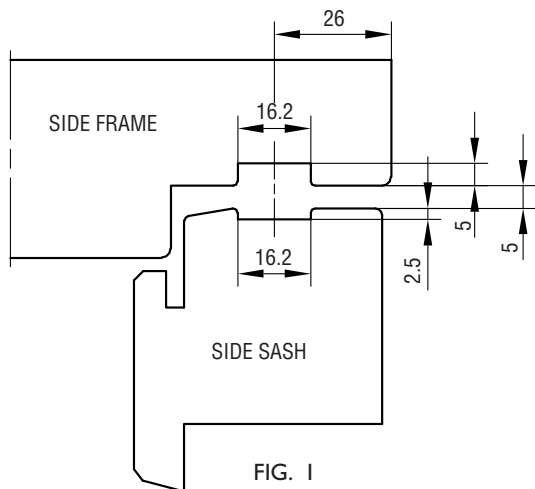

USE SCREW NO. 5.0.

MAINTENANCE:

TEST THE OPERATION FROM TIME TO TIME. WHEN FITTING - GREASE THE PIVOT/MOVABLE METAL PARTS OF THE MECHANISM WHILE ACTIVATING REPEATEDLY. HEREAFTER GREASE MINIMUM TWICE A YEAR. SEE ALSO INSTRUCTIONS ON PAGE 41 - 42.



A large, empty rectangular box with a thin blue border, occupying most of the page below the logo. It is intended for a drawing or illustration.



SIDE SWING WINDOW 90° WITH FRICTION IPA NO. 62595

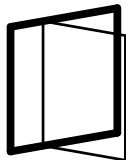

ORDERING NO.											
IPA NO.	MATERIAL			SURFACE		STANDARD PACKING IN BOXES OF 5 SETS	A MM	B MM	C MM	SCREW	APPROX. WEIGHT KGS / SET
	STEEL	LEFT	RIGHT	ELECTROPLATED							
62595	1	7	8	21		1	19	29,5	325	4,0	0,55

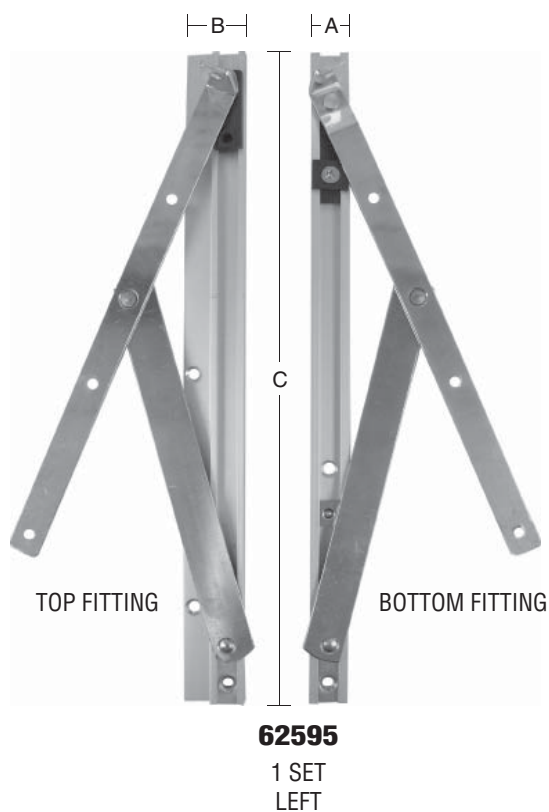

- ADJUSTABLE FRICTION
- CONVENIENT FOR CLEANING
- SWINGS 90°
- OPENS CLEAR FROM CURTAINS AND WINDOW FRAME
- MAX. VENTILATION
- CONCEALED FITTINGS
- ANODIZED ALUMINIUM RAILS

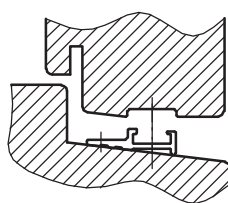

62595

FIRE-ESCAPE OPENING:
PLEASE SEE WWW.IPAFITTINGS.COM/RESCUE



IPA NO. 62595 FITTINGS INSTRUCTIONS

EXAMPLE - WOOD PROFIL

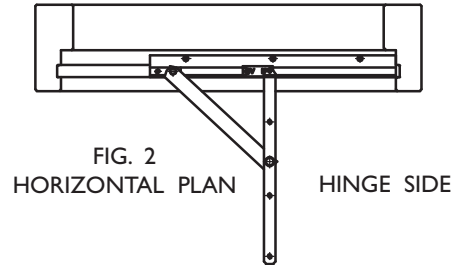
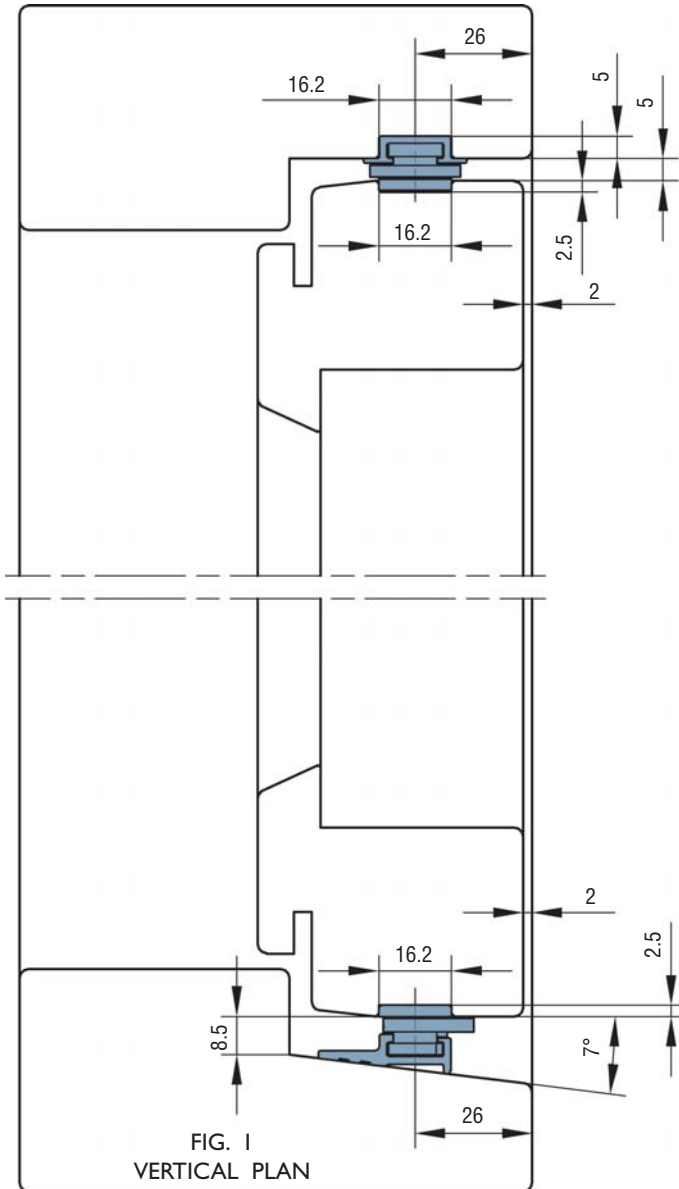

FITTING SHOWN ON FRAME CILL
RIGHT HAND ILLUSTRATION

IPA NO.	62595
MAX. WEIGHT OF SASH KGS.	40
MIN. WIDTH OF SASH MM	320
MAX. WIDTH OF SASH MM	820
SCREW	4.0

FIG. 3

REGARDING TALL WINDOWS:
PLEASE NOTE THAT ESPECIALLY ON TALL AND NARROW WINDOWS THE MOVEMENT OF THE TOP AND BOTTOM FITTING CAN BE DIFFERENT. BECAUSE OF THE DISTANCE BETWEEN TOP AND BOTTOM FITTING, THE WINDOW CAN BE DIFFICULT TO OPEN.

FITTING:

1. THE FITTING SHOULD BE POSITIONED IN TOP AND BOTTOM FRAME AND SCREWED ON (FIGURE 1 AND 2).
2. NOW PUSH THE WINDOW SASH INTO POSITION IN THE GROOVES AND FASTEN THE SCREWS. STARTING WITH THE SCREW IN THE STOP BRACKET.
3. THE FRICTION CAN BE ADJUSTED ON THE TOP FITTING. IF A LARGER OPENING IS WANTED THEN JUST MOVE THE ADJUSTABLE STOP FITTING IN THE TOP FRAME ALUMINIUM RAIL.

MAINTENANCE:

THE FITTINGS ARE NOT TO BE PAINTED. TEST THE OPERATION FROM TIME TO TIME. WHEN FITTING - LUBRICATE THE PIVOT/MOVABLE METAL PARTS OF THE MECHANISM WHILE ACTIVATING REPEATEDLY. HEREAFTER LUBRICATE MINIMUM TWICE A YEAR. DO NOT LUBRICATE THE ALUMINIUM RAILS. SEE ALSO INSTRUCTIONS ON PAGE 41 - 42.



TOPSWING FITTING

WOOD/ALU

IPA NO.s 62506-12, IPA NO. 62562 & IPA NO. 62155

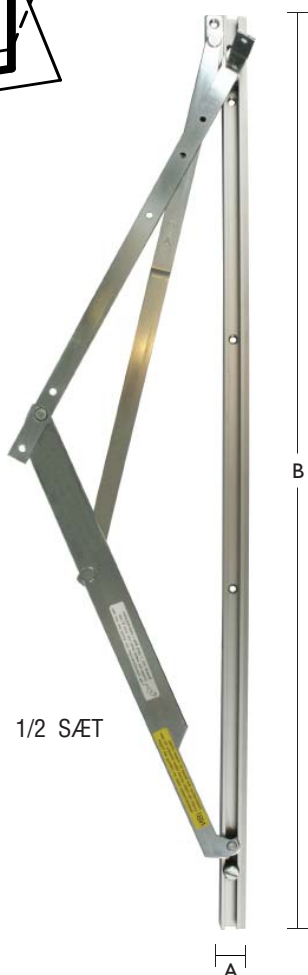
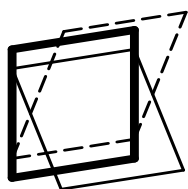

1/2 S/ET

ORDERING NO.									
IPA NO.	MATERIAL	W/O SPECIFICATION	SURFACE	STANDARD PACKING OF 1 SET PER CARTON	A MM	B MM	INNER FRAME MM	SCREW	APPROX. WEIGHT KGS / SET
	STEEL		ELECTROPLATED						
62506	1	0	21	1	18	744	744-843	4,0	1,44
62507	1	0	21	1	18	844	844-943	4,0	1,62
62508	1	0	21	1	18	944	944-1043	4,0	1,80
62509	1	0	21	1	18	1044	1044-1143	4,0	1,98
62510	1	0	21	1	18	1144	1144-1243	4,0	2,16
62511	1	0	21	1	18	1244	1244-1343	4,0	2,34
62512	1	0	21	1	18	1344	1344-1443	4,0	2,52

- CONSEALED FITTING
- ADJUSTABLE FRICTION
- FULLY REVERSIBLE 170°
- OPENS CLEAR OF CURTAINS AND WINDOW FRAME
- ANODIZED ALUMINIUM RAILS

FIRE-ESCAPE OPENING:
PLEASE SEE WWW.IPAFITTINGS.COM/RESCUE



SAFETY RESTRICTOR
IPA NO. 62562

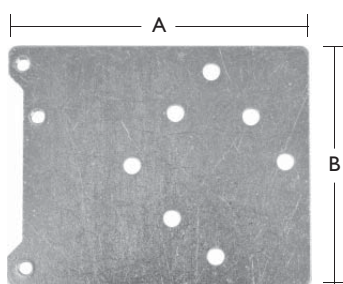

THREADED PLATE
IPA NO. 62155

ORDERING NO.							
IPA NO.	MATERIAL	LEFT	SURFACE	STANDARD PACKING IN BOXES OF 20 PCS.	A MM	SCREW	APPROX. WEIGHT KGS / PC.
	STEEL		ELECTROPLATED				
62562	1	7	21	1	170	3,5	0,08

ORDERING NO.									
IPA NO.	MATERIAL	W/O SPECIFICATION	SURFACE	STANDARD PACKING IN BOXES OF 25 PCS.	A MM	B MM	SCREW	APPROX. WEIGHT KGS / PC.	
	STEEL		ELECTROPLATED						
62155	1	0	21	1	80	70	4,0	0,12	



IPA NO.s 62506-12 & IPA NO. 62562 FITTINGS INSTRUCTIONS

IMPORTANT: THE SIDE FRAMES MUST BE STRAIGHT TO THE EFFECT THAT THE DISTANCE BETWEEN THE SIDE FRAMES (SLIDING RAILS) IS EXACTLY THE SAME FOR ANY HEIGHT OF THE FRAME. THIS IS IMPERATIVE FOR THE SLIDES TO TRAVEL FREELY IN THEIR ALUMINIUM RAILS.

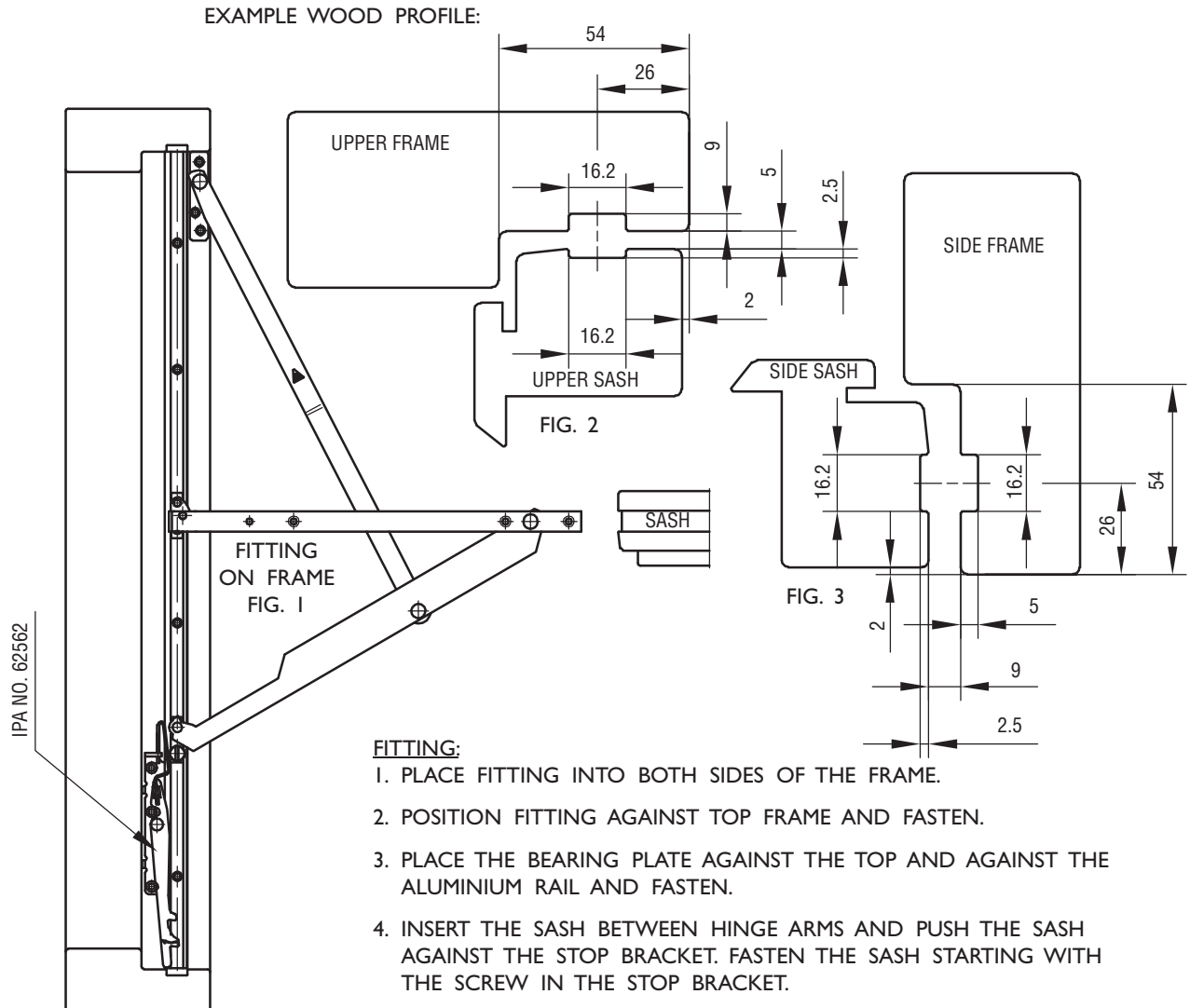

FITTING:

1. PLACE FITTING INTO BOTH SIDES OF THE FRAME.
2. POSITION FITTING AGAINST TOP FRAME AND FASTEN.
3. PLACE THE BEARING PLATE AGAINST THE TOP AND AGAINST THE ALUMINIUM RAIL AND FASTEN.
4. INSERT THE SASH BETWEEN HINGE ARMS AND PUSH THE SASH AGAINST THE STOP BRACKET. FASTEN THE SASH STARTING WITH THE SCREW IN THE STOP BRACKET.
5. THE SASH CAN BE OPENED TO ANY ANGLE. WITH LARGE OPENING ANGLE A LIGHT FRICTION CAN BE OBTAINED BY MEANS OF THE FRICTION SCREWS IN THE SIDES. THE FRICTION HAS TO BE THE SAME ON BOTH SIDES. PLEASE NOTE THAT THE SASH IS NOT SECURED FOR HEAVY WINDS AND OTHER HEAVY INFLUENCE.
6. FIT THE RESTRICTOR IPA NO. 62562 ON THE LEFT SIDE, SEE FIG. 1.

USE SCREW NO. 4.0.

OPERATION INSTRUCTIONS:

1. OPEN THE WINDOW - THE RESTRICTOR WILL AUTOMATICALLY RESTRICT THE WINDOW.
2. PULL THE SASH 20 MM - PRESS THE RESTRICTOR IN THE DIRECTION OF THE ARROW AND OPEN THE WINDOW.
3. WHEN THE WINDOW IS REVERSED FOR CLEANING, THE RESTRICTOR WILL LOCK AUTOMATICALLY. DISENGAGE AS MENTIONED IN POINT 2.

MAINTENANCE:

THE FITTINGS ARE NOT TO BE PAINTED. WHEN FITTING - LUBRICATE THE PIVOT/MOVABLE METAL PARTS OF THE MECHANISM WHILE ACTIVATING REPEATEDLY. HERAFTER LIBRICATE MINIMUM TWICE A YEAR. DO NOT GREASE THE ALUMINIUM RAILS. TEST THE OPERATION FROM TIME TO TIME. SEE ALSO INSTRUCTIONS ON PAGE 41 - 42.

IPA NO.	FITTING LENGTH MM	MAX. WEIGHT KGS.	INSIDE FRAME MM
62506	744	45	744-843
62507	844	45	844-943
62508	944	60	944-1043
62509	1044	60	1044-1143
62510	1144	60	1144-1243
62511	1244	60	1244-1343
62512	1344	60	1344-1444

USE THE LARGEST POSSIBLE FITTING

ATTENTION: MAX. WIDTH = HEIGHT + 300 MM, HOWEVER MAX. 1600 MM.



CANOPY STAYS WITH FRICTION IPA NO.s 62570-75

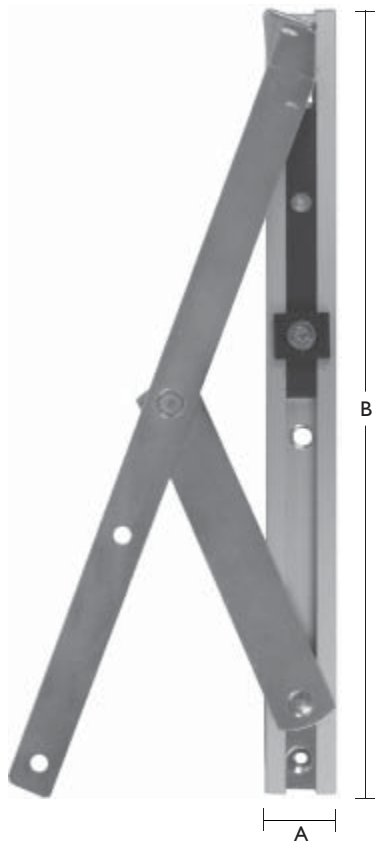
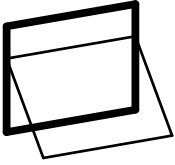

1/2 SET

ORDERING NO.									
IPA NO.	MATERIAL	W/O SPECIFICATION	SURFACE	STANDARD PACKING IN BOXES OF 5 SETS.	INDUSTRY PACKING IN BOXES OF 25 SETS.	A MM	B MM	SCREW	APPROX. WEIGHT KGS / SET
	STEEL		ELECTROPLATED						
62570	1	0	21	-	2	19	255	4.0	0.44
62573	1	0	21	-	2	19	445	4.0	0.64
62574	1	0	21	1	-	19	703	4.0	1.02
62575	1	0	21	1	-	19	152	4.0	0.26

- ADJUSTABLE FRICTION
- CONCEALED FITTINGS
- ANODIZED ALUMINIUM RAILS

FIRE-ESCAPE OPENING:
PLEASE SEE WWW.IPAFITTINGS.COM/RESCUE

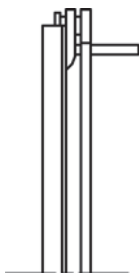

IPA NO. 62575

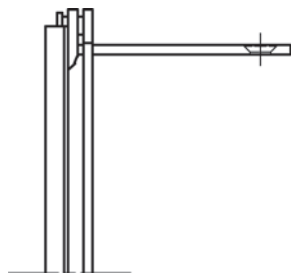

IPA NO.s 62570-74



IPA NO.s 62570-75 FITTINGS INSTRUCTIONS

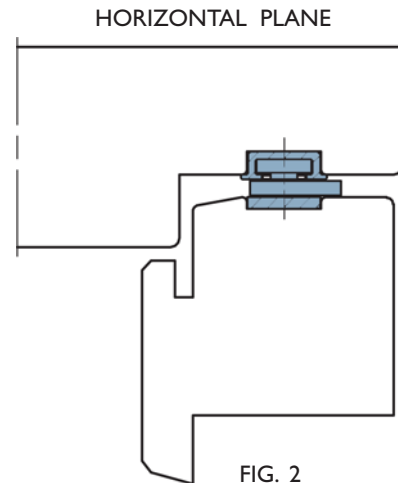
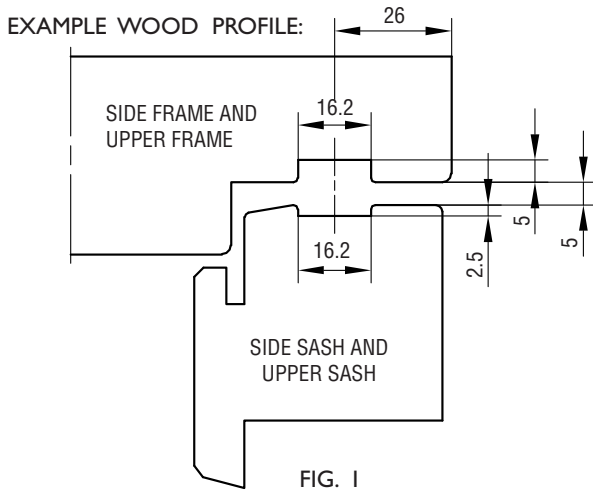

IPA NO.	62570	62573	62574	62575
MAX. SASH WEIGHT KG	40	50	70	20
MAX. INSIDE FRAME HEIGHT MM	844	1344	1544	310
USE SCREW NO.	4.0	4.0	4.0	4.0

ESPECIALLY FOR IPA NO. 62573 OG 62574:
THE SCREW IN THE TOP OF THE FRICTION ELEMENT IS ONLY TO ENSURE THAT THE GLIDING ELEMENT BELOW MOVES CORRECTLY IN THE ALUMINIUM RAIL. THEREFORE THIS SCREW MUST NOT BE ADJUSTED.

FITTING:

- CLOSE THE FITTING AND PLACE IT IN THE GROOVE OF THE SIDE FRAME.
PLACE THE FITTING AGAINST THE TOP FRAME.
PLACE AND FASTEN THE SCREW IN THE BOTTOM HOLE OF THE FITTING.
62573: FASTEN THE STOP PLATE THROUGH THE UPPER SCREW HOLE IN THE STOP PLATE AND THROUGH THE UPPER SCREW HOLE IN THE ALURAIL. THIS ENABLES MAX. FIRE ESCAPE OPENING. USE LOWER SCREW HOLE IN STOP PLATE TO ACHIEVE A MAX. SASH LOAD OF 60 KGS. IF LOWER SCREW HOLE IS USED THE FIRE ESCAPE OPENING WILL BE REDUCED.
62574: ALWAYS USE THE UPPER SCREW HOLE IN THE ALURAIL FOR FASTENING THE STOP PLATE. USE THE UPPER SCREW HOLE IN STOP PLATE FOR MAX. FIRE ESCAPE OPENING. USE THE MIDDLE SCREW HOLE IN THE STOP PLATE TO ACHIEVE A MAX. SASH LOAD OF 85 KGS.
USE THE LOWER SCREW HOLE IN THE STOP PLATE TO ACHIEVE A MAX. SASH LOAD OF 100 KGS.
IF MIDDLE OR LOWER SCREW HOLES IN STOP PLATE ARE USED THE FIRE ESCAPE OPENING WILL BE REDUCED.
- PUSH THE SASH INTO ITS PLACE BY INSERTING IT BETWEEN THE HINGE ARMS, GUIDED BY THE GROOVES IN THE SASH, UNTIL THE SASH HITS THE STOPS OF THE FITTING. THESE STOPS WILL GUARANTEE A 5 MM GAB BETWEEN FRAME AND SASH. FASTEN THE FITTING STARTING WITH THE SCREW IN THE STOP BRACKET (IPA NO. 62570-74).
- NOW THE FRICTION MAY BE ADJUSTED BY MEANS OF THE SCREWS IN THE SLIDES. THE BEST RESULT FOR THE WINDOW MOVEMENT IS ACHIEVED BY EQUAL FRICTION IN EITHER SIDE.

OBS! RE. IPA NO. 62573:

FOR BIG WINDOWS (>1200 MM) WITH 3-LAYER GLASS AND NO REQUIREMENTS FOR EGRESS OPENINGS THE USE OF IPA NO. 62574 IS RECOMMENDED, AS THE VENTILATION POSITION OTHERWISE MAY BE DIFFICULT TO ACHIEVE BECAUSE OF THE OPENING GEOMETRY OF THE GEARS.

MAINTENANCE:

THE FITTINGS ARE NOT TO BE PAINTED. TEST THE OPERATION FROM TIME TO TIME. WHEN FITTING - LUBRICATE THE PIVOT/MOVABLE METAL PARTS OF THE MECHANISM WHILE ACTIVATING REPEATEDLY. HEREAFTER LUBRICATE MINIMUM TWICE A YEAR. DO NOT LUBRICATE THE ALUMINIUM RAILS. SEE ALSO INSTRUCTIONS ON PAGE 41 - 42.

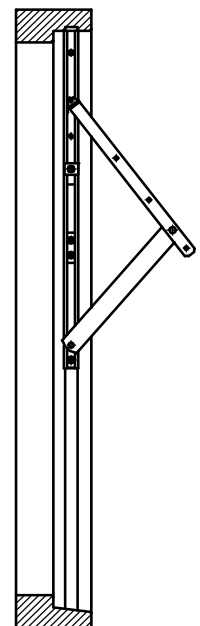
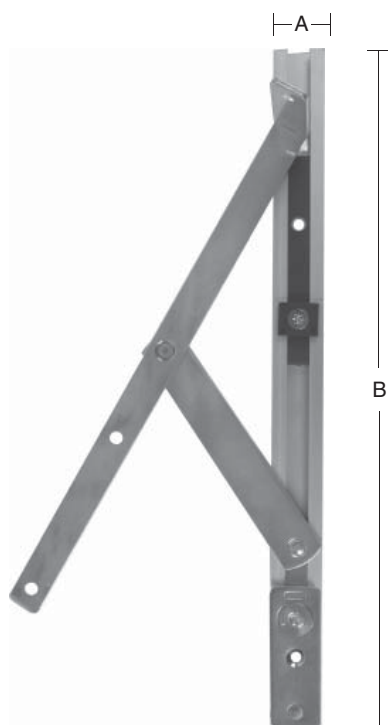
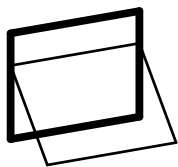

FIG. 3



ADJUSTABLE CANOPY STAYS WITH FRICTION

IPA NO.s 62586-87 + 89



1/2 SET

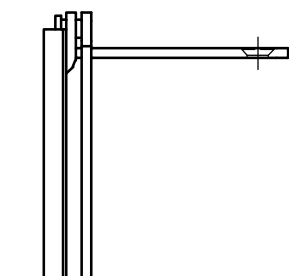

ORDERING NO.								
IPA NO.	MATERIAL	W/O SPECIFICATION	SURFACE	INDUSTRY PACKING IN BOXES OF 25 SETS.	A MM	B MM	SCREW	APPROX. WEIGHT KGS / SET
	STEEL		ELECTROPLATED					
62586	1	0	21	2	19	306	4,0	0,53
62587	1	0	21	2	19	496	4,0	0,74
62589	1	0	21	2	19	755	4,0	1,15

- VERTICALLY ADJUSTABLE ± 1.5 MM
- ADJUSTABLE FRICTION
- CONCEALED FITTINGS
- ANODIZED ALUMINIUM RAILS

FIRE-ESCAPE OPENING:
PLEASE SEE WWW.IPAFITTINGS.COM/RESCUE



IPA NO.s 62586-87 + 89 FITTINGS INSTRUCTIONS

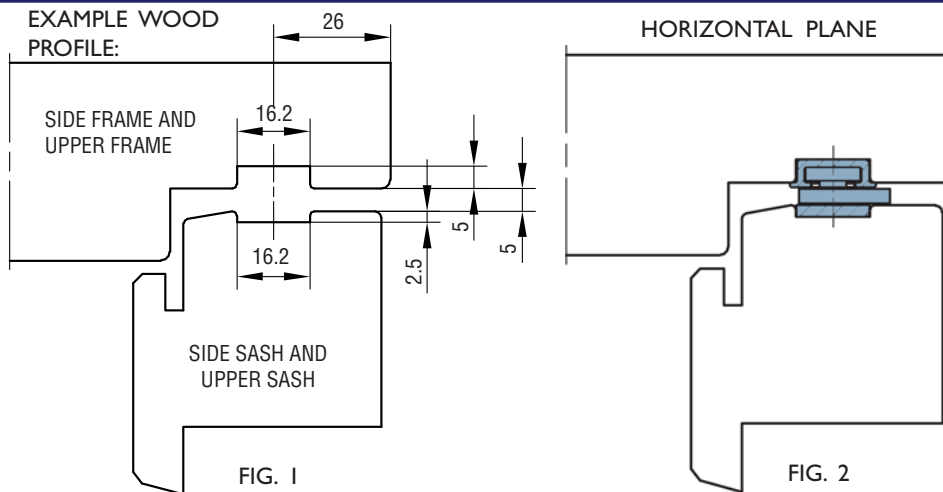

OBS! RE. IPA NO. 62587:
FOR BIG WINDOWS (>1200 MM) WITH 3-LAYER GLASS AND NO REQUIREMENTS FOR EGRESS OPENINGS THE USE OF IPA NO. 62589 IS RECOMMENDED, AS THE VENTILATION POSITION OTHERWISE MAY BE DIFFICULT TO ACHIEVE BECAUSE OF THE OPENING GEOMETRY OF THE GEARS.

IPA NO.	62586	62587	62589
MAX. SASH WEIGHT KG	40	50	70
MAX. INSIDE FRAME HEIGHT MM	844	1344	1544
USE SCREW NO.	4.0	4.0	4.0

ESPECIALLY FOR IPA NO. 62587 OG 62589:
THE SCREW IN THE TOP OF THE FRICTION ELEMENT IS ONLY TO ENSURE THAT THE GLIDING ELEMENT BELOW MOVES CORRECTLY IN THE ALUMINIUM RAIL. THEREFORE THIS SCREW MUST NOT BE ADJUSTED.

FITTING:

- CLOSE THE FITTING AND PLACE IT IN THE GROOVE OF THE SIDE FRAME.
PLACE THE FITTING AGAINST THE TOP FRAME.
PLACE AND FASTEN THE SCREW IN THE BOTTOM HOLE OF THE FITTING.
62587: FASTEN THE STOP PLATE THROUGH THE UPPER SCREW HOLE IN THE STOP PLATE AND THROUGH THE UPPER SCREW HOLE IN THE ALURAIL. THIS ENABLES MAX. FIRE ESCAPE OPENING. USE LOWER SCREW HOLE IN STOP PLATE TO ACHIEVE A MAX. SASH LOAD OF 60 KGS. IF LOWER SCREW HOLE IS USED THE FIRE ESCAPE OPENING WILL BE REDUCED.
62589: ALWAYS USE THE UPPER SCREW HOLE IN THE ALURAIL FOR FASTENING THE STOP PLATE. USE THE UPPER SCREW HOLE IN STOP PLATE FOR MAX. FIRE ESCAPE OPENING.
USE THE MIDDLE SCREW HOLE IN THE STOP PLATE TO ACHIEVE A MAX. SASH LOAD OF 85 KGS.
USE THE LOWER SCREW HOLE IN THE STOP PLATE TO ACHIEVE A MAX. SASH LOAD OF 100 KGS.
IF MIDDLE OR LOWER SCREW HOLES IN STOP PLATE ARE USED THE FIRE ESCAPE OPENING WILL BE REDUCED.
- PUSH THE SASH INTO ITS PLACE BY INSERTING IT BETWEEN THE HINGE ARMS, GUIDED BY THE GROOVES IN THE SASH, UNTILL THE SASH HITS THE STOPS OF THE FITTING. THESE STOPS WILL GUARANTEE A 5 MM GAB BETWEEN FRAME AND SASH. FASTEN THE FITTING STARTING WITH THE SCREW IN THE STOP BRACKET.
- NOW THE FRICTION MAY BE ADJUSTED BY MEANS OF THE SCREWS IN THE SLIDES. THE BEST RESULT FOR THE WINDOW MOVEMENT IS ACHIEVED BY EQUAL FRICTION AT EITHER SIDE.
- THE SASH CAN BE ADJUSTED ± 1.5 MM UP OR DOWN. ADJUST BY USING A TORX-20 KEY TO TURN THE ECCENTRIC SCREW. BY DELIVERY THE MARK ON THE ECCENTRIC SCREW IS IN A VERTICAL POSITION INDICATING THE 0-POSITION. WHEN THE MARK IS IN HORIZONTAL POSITION IN EITHER TOP OR BOTTOM, THE FITTING IS ADJUSTED TO IT'S MAX OF ± 1.5 MM

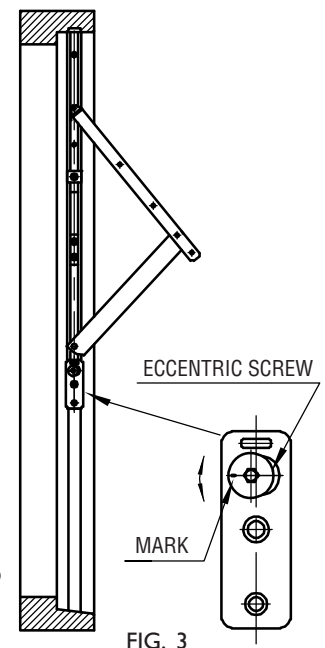

MAINTENANCE:

THE FITTINGS ARE NOT TO BE PAINTED. TEST THE OPERATION FROM TIME TO TIME. WHEN FITTING - LUBRICATE THE PIVOT/MOVABLE METAL PARTS OF THE MECHANISM WHILE ACTIVATING REPEATEDLY. HEREAFTER LUBRICATE MINIMUM TWICE A YEAR. DO NOT LUBRICATE THE ALUMINIUM RAILS. SEE ALSO INSTRUCTIONS ON PAGE 41 - 42



ADJUSTABLE CANOPY STAY WITH ADJUSTABLE FRICTION IPA NO. 62588

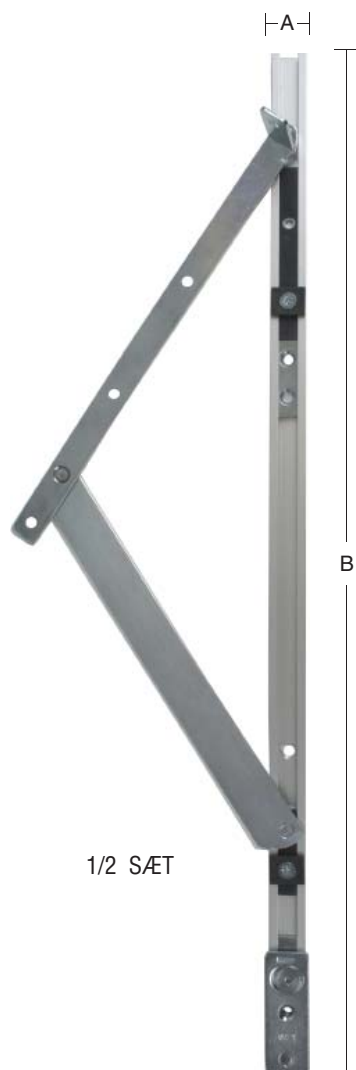
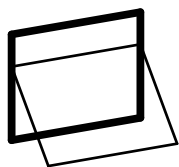

1/2 SÆT

ORDERING NO.								
IPA NO.	MATERIAL	W/O SPECIFICATION	SURFACE	STANDARD PACKING IN BOXES OF 5 SETS.	A MM	B MM	SCREW	APPROX. WEIGHT KGS / SET
	STEEL		ELECTROPLATED					
62588	1	0	21	1	19	537	4.0	0,76

- VERTICALLY ADJUSTABLE ± 1.5 MM
- ADJUSTABLE FRICTION
- CONCEALED FITTINGS
- ANODIZED ALUMINIUM RAILS

FIRE-ESCAPE OPENING:
PLEASE SEE WWW.IPAFITTINGS.COM/RESCUE

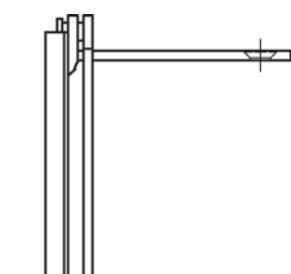



IPA NO. 62588 FITTINGS INSTRUCTIONS

EXAMPLE WOOD PROFILE:

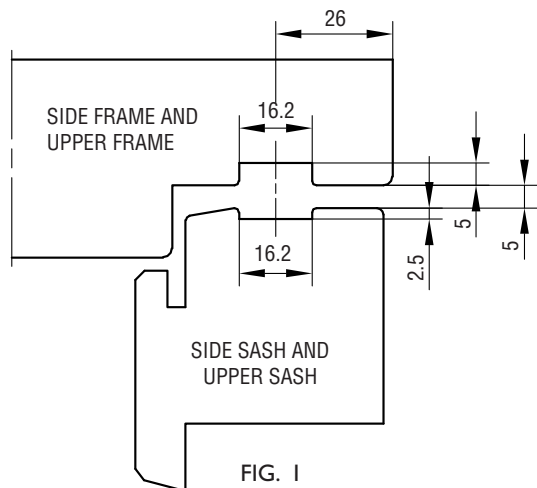

FIG. 1

HORIZONTAL PLANE

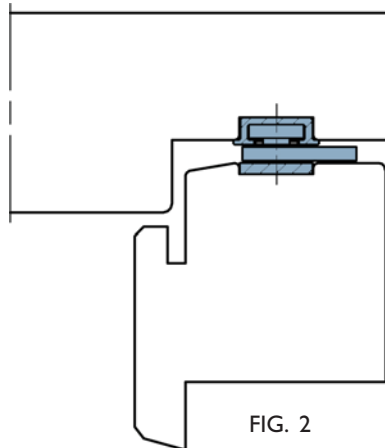

FIG. 2

IPA NO.	62588
MAX. SASH WEIGHT KG	50
MAX. INSIDE FRAME HEIGHT MM	1144
USE SCREW NO.	4.0

FITTING:

1. CLOSE THE FITTING AND PLACE IT IN THE GROOVE OF THE SIDE FRAME. PLACE THE FITTING AGAINST THE TOP FRAME. PLACE AND FASTEN THE SCREW IN THE BOTTOM HOLE OF THE FITTING. OPEN THE FITTING AND FASTEN THE REMAINING SCREWS.
2. PUSH THE SASH INTO ITS PLACE BY INSERTING IT BETWEEN THE HINGE ARMS, GUIDED BY THE GROOVES IN THE SASH, UNTILL THE SASH HITS THE STOPS OF THE FITTING. THESE STOPS WILL GUARANTEE A 5 MM GAB BETWEEN FRAME AND SASH. FASTEN THE FITTING STARTING WITH THE SCREW IN THE STOP BRACKET.
3. NOW THE FRICTION MAY BE ADJUSTED BY MEANS OF THE SCREWS IN THE SLIDES. WHEN ADJUSTING LET THE TOP GLIDER MOVE DOWN TO THE STOP. THE BEST RESULT FOR THE WINDOW MOVEMENT IS ACHIEVED BY EQUAL FRICTION IN EITHER SIDE.
4. THE SASH CAN BE ADJUSTED ± 1.5 MM UP OR DOWN. ADJUST BY USING A TORX-20 KEY TO TURN THE ECCENTRIC SCREW. BY DELIVERY THE MARK ON THE ECCENTRIC SCREW IS IN A VERTICAL POSITION INDICATING THE 0-POSITION. WHEN THE MARK IS IN HORIZONTAL POSITION IN EITHER TOP OR BOTTOM, THE FITTING IS ADJUSTED TO IT'S MAX OF ± 1.5 MM.

MAINTENANCE:

THE FITTINGS ARE NOT TO BE PAINTED. TEST THE OPERATION FROM TIME TO TIME. WHEN FITTING - LUBRICATE THE PIVOT/MOVABLE METAL PARTS OF THE MECHANISM WHILE ACTIVATING REPEATEDLY. HEREAFTER LUBRICATE MINIMUM TWICE A YEAR. DO NOT LUBRICATE THE ALUMINIUM RAILS. SEE ALSO INSTRUCTIONS ON PAGE 41 - 42.

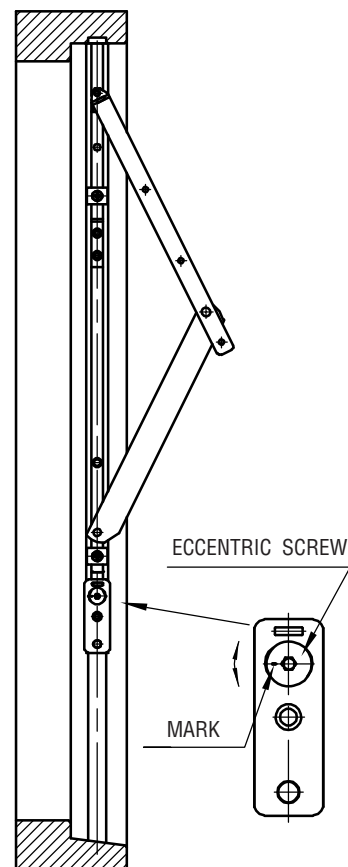
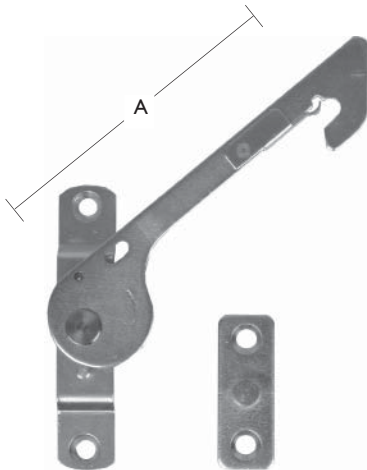
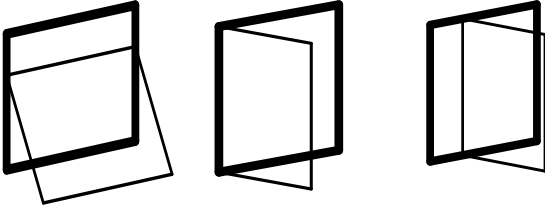

FIG. 3



SAFETY CATCH

IPA NO. 62536



1 SET
RIGHT

ORDERING NO.								
IPA NO.	MATERIAL			SURFACE	STANDARD PACKING IN BOXES OF 5 SETS	A MM	SCREW	APPROX. WEIGHT KG / SET
	STEEL	LEFT	RIGHT	ELECTROPLATED				
62536	1	7	8	21	1	92	4.0	0.06



IPA NO. 62536 FITTINGS INSTRUCTIONS

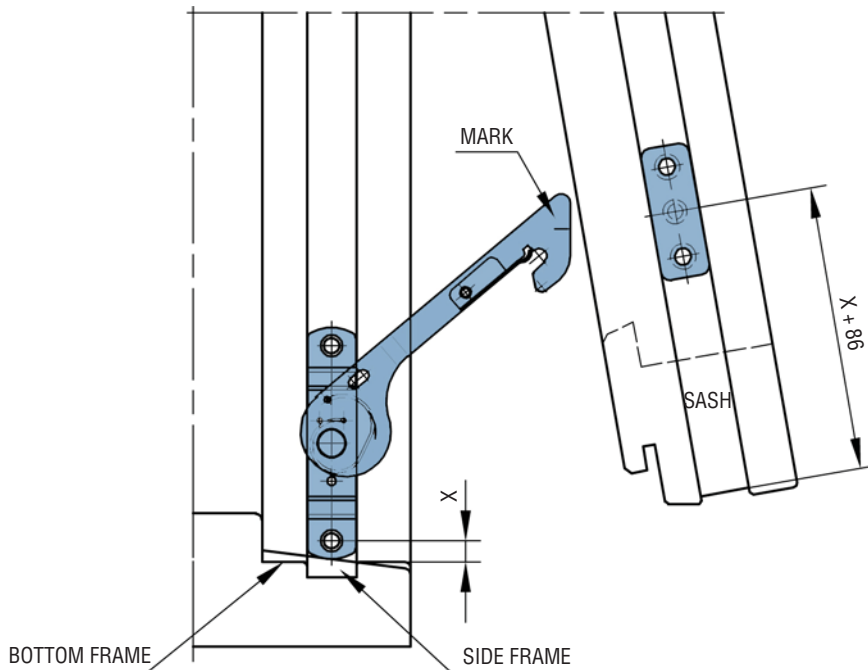

FIG. 1
RIGHT HAND ILLUSTRATION

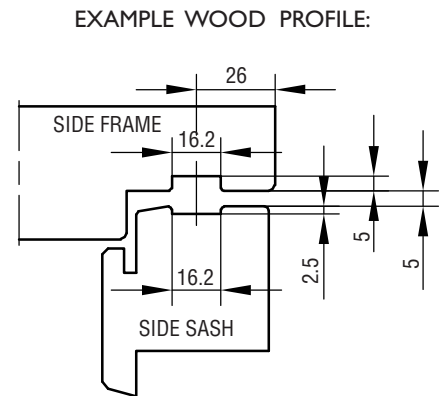

FIG. 2

THE FITTING CAN BE USED ON BOTH TOPHUNG/TOPGUIDED AS WELL AS SIDEHUNG/SIDEGUIDED WINDOWS. ON TOPHUNG/TOPGUIDED WINDOWS THE RESTRICTOR IS PLACED IN THE BOTTOM OF THE SIDE FRAME AND THE RECEIVER IS PLACED IN THE BOTTOM OF THE SIDE SASH. ON THE SIDEHUNG/SIDEGUIDED WINDOWS THE RESTRICTOR IS PLACED IN TOP FRAME ON THE OPPOSITE SIDE OF THE HINGES AND THE RECEIVER IS PLACED IN THE TOP SASH OPPOSITE THE HINGES.

X-DIMENSION IS OPTIONAL. ON TOPHUNG/TOPGUIDED WINDOWS X MUST MINIMUM BE 7 MM. BY USING LARGER X-DIMENSION THE VENTILATION OPENING WILL BE EXTENDED.

IMPORTANT: THE RECEIVER MUST BE MOUNTED SO THAT IT HITS THE MARK ON THE RESTRICTOR ARM WHEN THE WINDOW IS CLOSED. SEE FIG. 1

OPERATING INSTRUCTIONS:

1. OPEN THE WINDOW UNTIL THE RESTRICTOR ENGAGES.
2. PULL THE SASH APPROXIMATELY 20 MM BACKWARDS.
3. PRESS THE RESTRICTOR OUTWARDS AS YOU OPEN THE WINDOW.
4. WHEN THE WINDOW IS CLOSED THE RESTRICTOR RE-ENGAGES AUTOMATICALLY.

USE SCREW NO. 4.0

MAINTENANCE:

THE FITTINGS ARE NOT TO BE PAINTED. TEST THE OPERATION FROM TIME TO TIME. WHEN FITTING - LUBRICATE THE PIVOT/MOVABLE METAL PARTS OF THE MECHANISM WHILE ACTIVATING REPEATEDLY. HEREAFTER LUBRICATE MINIMUM TWICE A YEAR. DO NOT LUBRICATE THE ALUMINIUM RAILS. SEE ALSO INSTRUCTIONS ON PAGE 41 - 42.



FRICITION STAY for windows

IPA NO. 62527

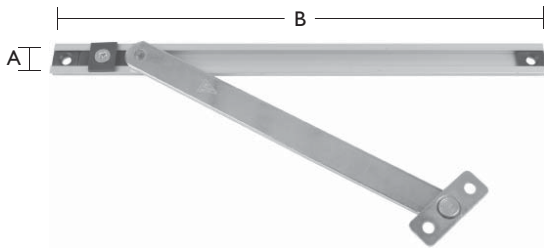
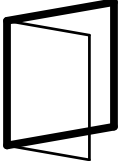

ORDERING NO.									
IPA NO.	MATERIAL	W/O SPECIFICATION	SURFACE	STANDARD PACKING IN BOXES OF 25 PCS.	A MM	B MM	MATERIAL MM	SCREW	APPROX. WEIGHT KG / PC.
	STEEL		ELECTROPLATED						
62527	1	0	21	1	19	274	17X3	4.0	0.14

- CONCEALED FITTING
- OPENS UP TILL 100°
- FRICTION IN ALL POSITIONS
- ADJUSTABLE FRICTION
- ANODIZED ALUMINIUM RAIL



IPA NO. 62527

FITTING INSTRUCTIONS

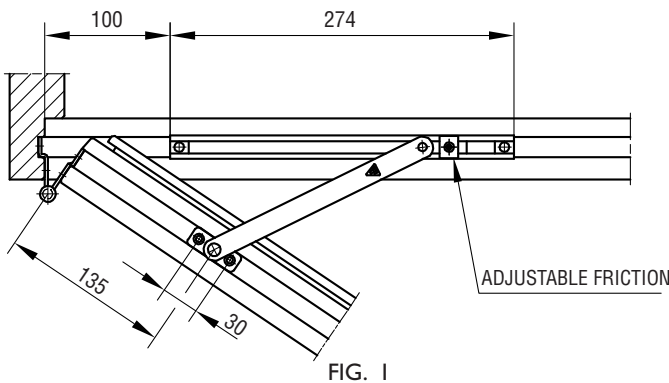

EXAMPLE WOOD PROFILE:

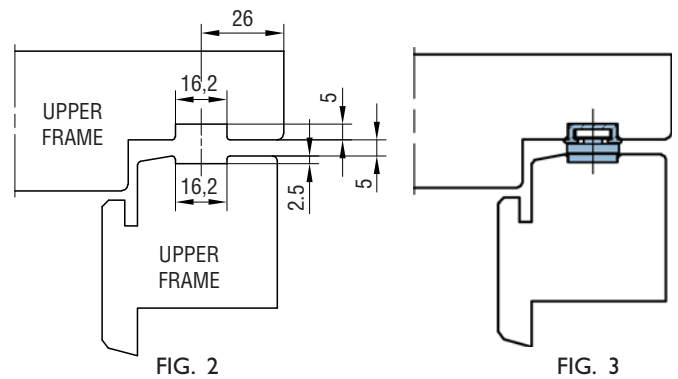

MAINTENANCE:

THE FITTING ARE NOT TO BE PAINTED. TEST THE OPERATION FROM TIME TO TIME. WHEN MOUNTING - LUBRICATE THE PIVOT/MOVABLE METAL PARTS OF THE MECHANISM WHILE ACTIVATING REPEATEDLY. HERAFTER LUBRICATE MINIMUM TWICE A YEAR. DO NOT LUBRICATE THE ALUMINIUM RAIL. SEE ALSO INSTRUCTIONS ON PAGE 41 - 42.



FRICITION STAY for doors

IPA NO. 63511

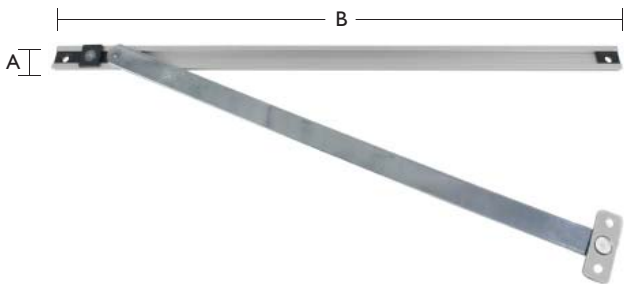
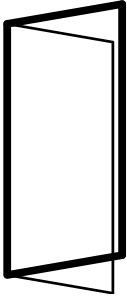

ORDERING NO.									
IPA NO.	MATERIAL	W/O SPECIFICATIONS	SURFACE	STANDARD PACKING IN BOXES OF 10 PCS.	A MM	B MM	MATERIAL MM	SCREW	APPROX. WEIGHT KG / PCS.
	STEEL		ELECTROPLATED						
63511	1	0	21	1	19	414	17X3	4.0	0.22

- CONCEALED FITTING
- OPENS UP TILL 100°
- FRICTION IN ALL POSITIONS
- ADJUSTABLE FRICTION
- ANODIZED ALUMINIUM RAIL



IPA NO. 63511

FITTING INSTRUCTIONS

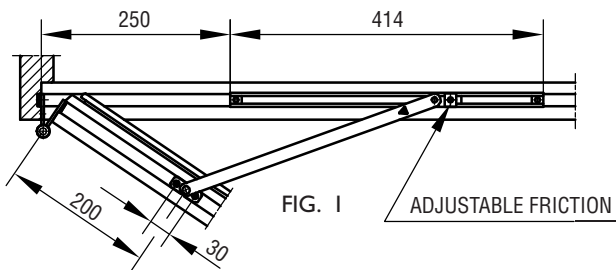

EXAMPLE WOOD PROFILE:

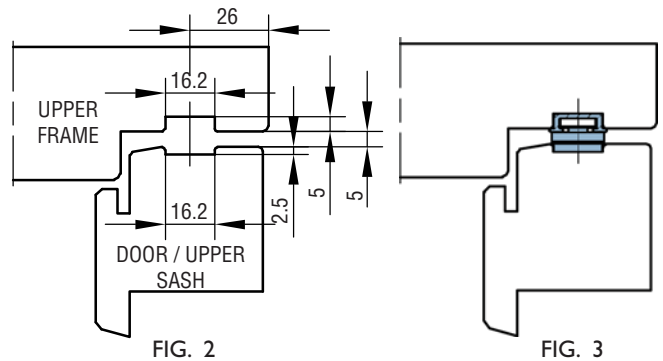

MAINTENANCE:
 THE FITTING ARE NOT TO BE PAINTED. TEST THE OPERATION FROM TIME TO TIME. WHEN MOUNTING - LUBRICATE THE PIVOT/MOVABLE METAL PARTS OF THE MECHANISM WHILE ACTIVATING REPEATEDLY. HERAFTER LUBRICATE MINIMUM TWICE A YEAR. DO NOT LUBRICATE THE ALUMINIUM RAIL. SEE ALSO INSTRUCTIONS ON PAGE 41 - 42.



ACCESSORIES

SUPPORT FITTING AND GUIDE BLOCK

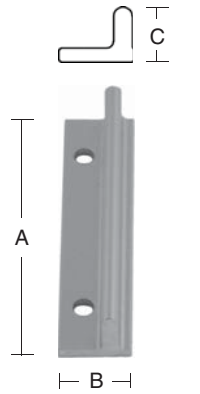

SUPPORT FITTING
IPA NO. 62222

ORDERING NR.											A MM	B MM	C MM	SCREW HOLES MM	SCREW	APPROX. WEIGHT KG / PIECES
IPA NO.	MATERIAL		W/O SPECIFICATION	SURFACE			STANDARD PACKING IN BOXES OF 20 PIECES	STANDARD PACKING IN BOXES OF 25 PIECES	STANDARD PACKING IN BOXES OF 100 PIECES	INDUSTRY PACKING IN BOXES OF 100 PIECES						
	ALUMINIUM	PLASTIC		ANODIZED	GREY	BLACK										
62222	0	-	0	00	-	-	-	1	-	-	70	16	12	5	-	0,05
63230	-	9	0	-	54	-	1	-	-	-	42	20	10	-	4,0	0,04
	-	9	0	-	-	58	-	-	-	2						
63235	-	9	0	-	54	-	-	-	1	-	25	26	12	-	4,0	0,04

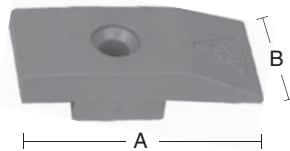

GUIDE BLOCK
IPA NO. 63230

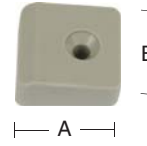

GUIDE BLOCK
IPA NO. 63235

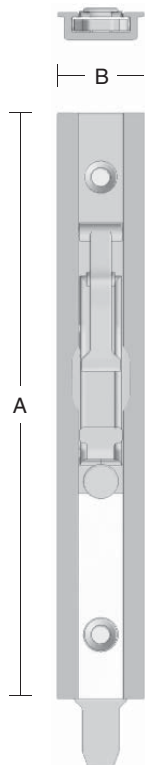

IPA NO.s 63508-09

FLUSH BOLT

BESTILLINGSNR.					A MM	B MM	THICKNESS MM	BOLT MM	LENGTH BOLT MM	SCREW	APPROX. WEIGHT KG / PIECES
IPA NO.	MATERIAL	SURFACE		STANDARD PACKING IN BOXES OF 20 PIECES							
	STEEL	SQUARE EDGES	ELECTROPLATED								
63508	1	5	21	1	128	19	6	8,5 X 2,5	15	3,5	0,04
63509	1	5	21	1	128	19	6	8,5 X 2,5	20	3,5	0,04



ACCESSORIES

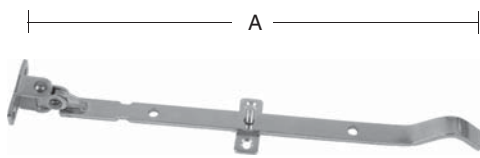

IPA NO.s 21311-13

CASEMENT STAYS

ORDERING NO.										
IPA NO.	MATERIAL	WITHOUT SPECIFICATION	SURFACE			STANDARD PACKING IN BOXES OF 10 PCS.	A MM	MATERIAL MM	SCREW	APPROX. WEIGHT KG / PIECES
	STEEL		ELECTROPL. / WHITE	ELECTROPLATED	ELECTROPL. YELLOW					
21311	1	0	06	21	25	1	220	15 X 4	4,0	0,17
21313	1	0	06	21	25	1	310	15 X 4	4,0	0,21

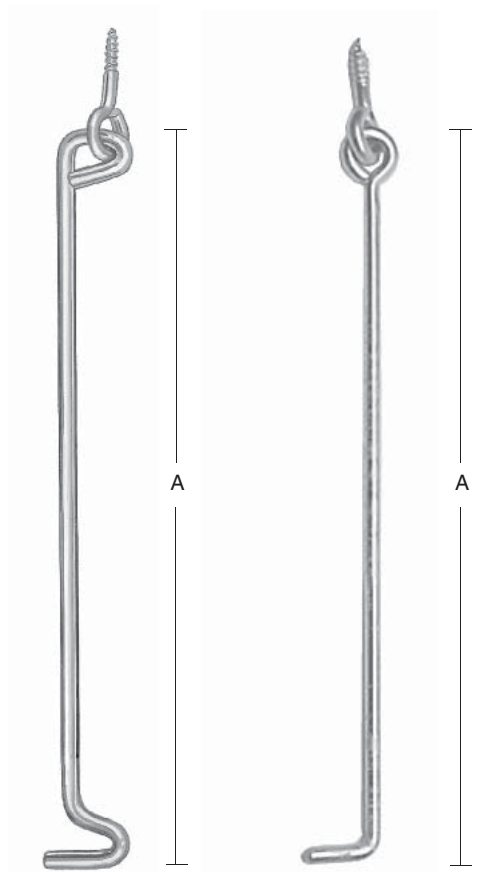

IPA NO.s 21343-55

IPA NO. 21357

CASEMENT HOOKS

BESTILLINGSNR.											
IPA NO.	MATERIAL	WITHOUT SPECIFICATION	SURFACE				STANDARD PACKING IN BOXES OF 25 PIECES.	SINGLE PIECES	A MM	TICKNESS MM	APPROX. WEIGHT KG / 100 PIECES
	STEEL		ELECTROPL. / WHITE	ELECTROPLATED	ELECTROPL. YELLOW	GALVANIZED					
21343	1	0	06	-	25	87	1	-	105	6	5,0
21345	1	0	06	21	25	87	1	-	155	6	6,4
21347	1	0	06	21	25	87	1	-	210	6	7,5
21349	1	0	06	-	25	87	1	-	260	6	8,8
21351	1	0	06	-	25	87	1	-	310	6	10,0
21353	1	0	06	-	25	87	1	-	390	6	11,8
21355	1	0	06	-	-	87	1	-	470	6	13,5
21357	1	0	-	-	-	87	-	3	625	8	36,6



ACCESSORIES

HOOK HOLDERS



IPA NO. 21359



IPA NO. 21360

		ORDERING NO.									
IPA NO.	MATERIAL	WITHOUT SPECIFICATION	SURFACE		STANDARD PACKING IN BOXES OF 25 PIECES	STANDARD PACKING IN BOXES OF 100 PIECES	A MM	B MM	SCREW	APPROX. WEIGHT KG / 100 PIECES	
	PLASTIC		GREY	WHITE							
21359	9	0	-	56	-	1	18,5	9,5	-	0,10	
21360	9	0	54	56	1	-	19	12	3,5	0,19	

HOOK CATCHES AND NAILS



IPA NO.s 21361-63

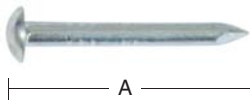

IPA NO. 21369

		ORDERING NO.											
IPA NO.	MATERIAL	WITHOUT SPECIFICATION	SURFACE				STANDARD PACKING IN BOXES OF 25 PIECES	STANDARD PACKING IN BOXES OF 100 PIECES	STANDAR DPACKING IN BOXES OF 1 KG	A MM	HOLE MM	THICKNESS MM	APPROX. WEIGHT KG / PIECES
	STEEL		ELECTROPL. / WHITE	ELECTROPLATED	ELECTROPL. YELLOW	GALVANIZED							
21361	1	0	-	21	25	-	-	1	-	25	8	4,0	0,6
21363	1	0	06	21	25	87	1	-	-	25	8	4,7	0,8
21369	1	0	06	21	25	-	-	-	1	25	-	2,5	0,1

HOOK CATCHES

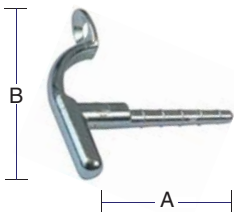

IPA NO. 21381

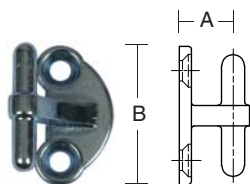

IPA NO. 21382

		ORDERING NO.																
IPA NR.	MATERIAL			WITHOUT SPECIFICATION	SURFACE				STANDARD PACKING IN BOXES OF 50 PIECES	STANDARD PACKING IN BOXES OF 100 PIECES	INDUSTRY PACKING IN BOXES OF 100 PIECES	INDUSTRY PACKING IN BOXES OF 250 PIECES	A MM	B MM	PIN MM	HOLE MM	SCREW	APPROX. WEIGHT KG / 100 PIECES
	STEEL	BRASS	ZINC		ELECTROPL. / WHITE	ELECTROPLATED	ELECTROPL. YELLOW	POLISHED										
21381	1	-	-	0	06	21	25	-	-	1	-	2	28	47	5,5	3,5	-	0,75
	-	6	-	0	-	-	-	85	1	-	2	-						0,75
	-	-	0	0	06	21	25	-	-	-	-	2						26
21382	1	-	-	0	06	-	-	-	1	-	-	-	13,3	34	5,6	-	3,5	1,4
	1	-	-	0	-	21	25	-	1	-	-	2						



CASEMENT HOOK

IPA NO.s 21370 - 79

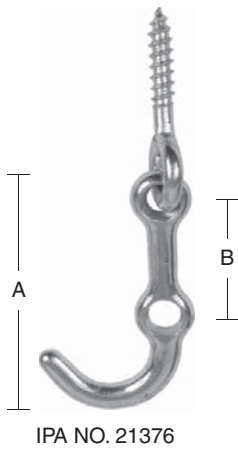

ORDERING NO.																
IPA NO.	MATERIAL			WITHOUT SPECIFICATION	SURFACE				STANDARD PACKING IN BOXES OF 50 PIECES	STANDARD PACKING IN BOXES OF 100 PIECES	INDUSTRY PACKING IN BOXES OF 100 PIECES	INDUSTRY PACKING IN BOXES OF 250 PIECES	AMM	B MM	HOLE FOR PIN MM	APPROX. WEIGHT KG / 100 PIECES
	ZINK ALLOY	STEEL	BRASS		ELECTROPL. / WHITE	ELECTROPLATED	ELECTROPL. YELLOW	POLISHED								
21370	0	-	-	0	06	21	25	-	-	-	2	130	95	6	5,0	
21371	0	-	-	0	06	21	25	-	-	-	2	130	95	6	6,0	
21372	-	1	-	0	06	-	-	-	1	-	-	130	95	6	5,0	
	-	1	-	0	-	21	25	-	1	-	2					
21373	-	1	-	0	06	21	25	-	1	-	2	170	140	6	6,0	
	-	1	-	0	06	21	25	-	-	1	-					
21376	-	1	-	0	-	21	-	-	-	-	2	54	27	6	1,3	
	-	1	-	0	-	21	-	-	-	-	2					
21378	0	-	-	0	-	-	25	-	1	-	-	120	93	6	4,8	
	0	-	-	0	06	21	25	-	-	-	2					
21379	0	-	-	0	-	21	25	-	1	-	-	120	93	6	5,6	
	0	-	-	0	06	21	25	-	-	-	2					

ATTENTION: IPA NO. 21378 + 79 IN POWDER PAINTED VERSIONS CAN ONLY BE USED TOGETHER WITH IPA NO. 21382.

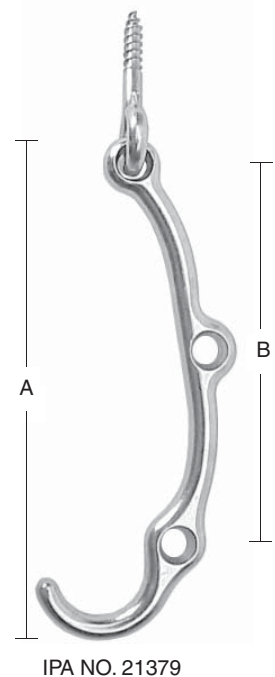
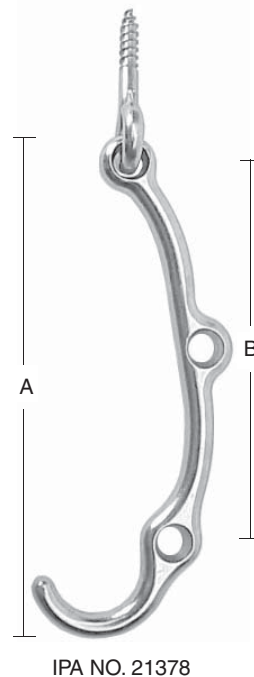
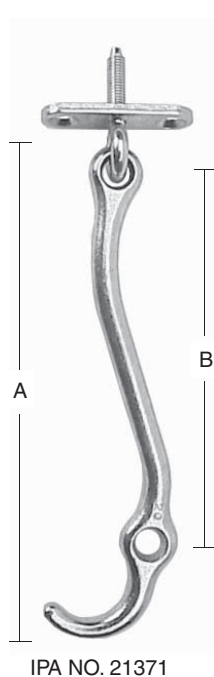
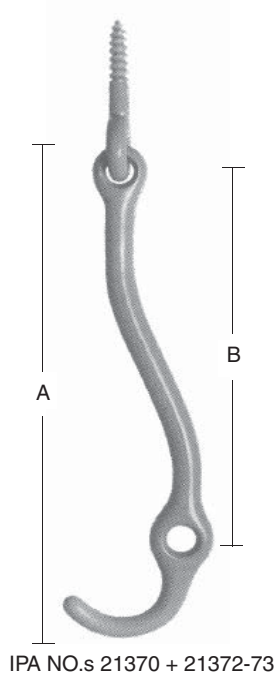



IPA NO.s 21370 - 73 & 21378 - 79 & 21381-82 FITTINGS INSTRUCTIONS

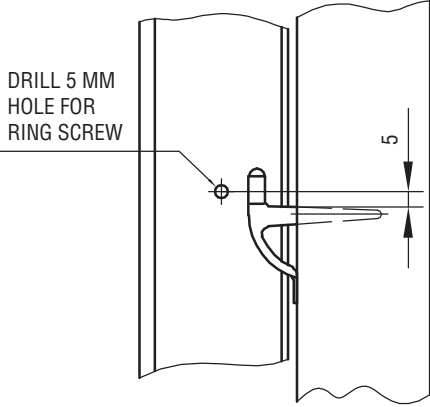

FIG. 1
IPA NO. 21381
FOR HOOK-CATCHES Ø3-Ø3,2 MM
PRE-DRILLING IS RECOMMENDED

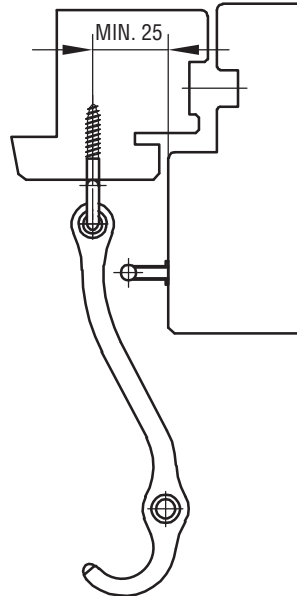

FIG. 2
IPA NO. 21372 WITH 21381

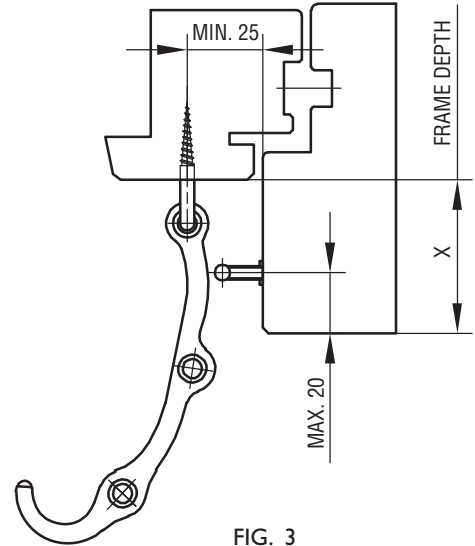

FIG. 3
IPA NO. 21378 WITH 21381

THE MENTIONED MAX. AND MIN. DIMENSIONS APPLY FOR A FRAME DEPTH (X ON THE DRAWING) OF AS MUCH AS 50 MM. IF X IS BIGGER THAN 50 MM, WE RECOMMEND USING IPA NO. 21372

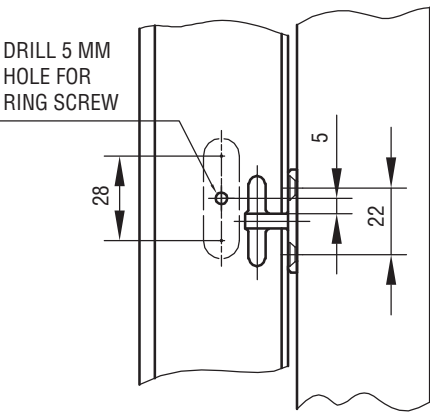

FIG. 4
IPA NO. 21382

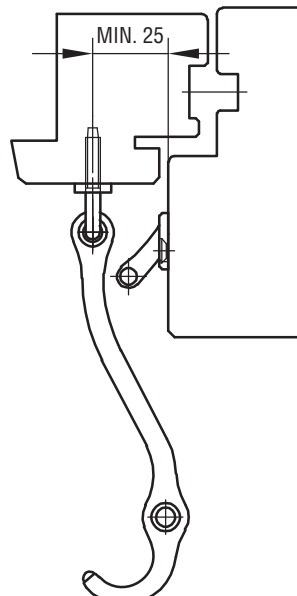

FIG. 5
IPA NO. 21371 WITH 21382

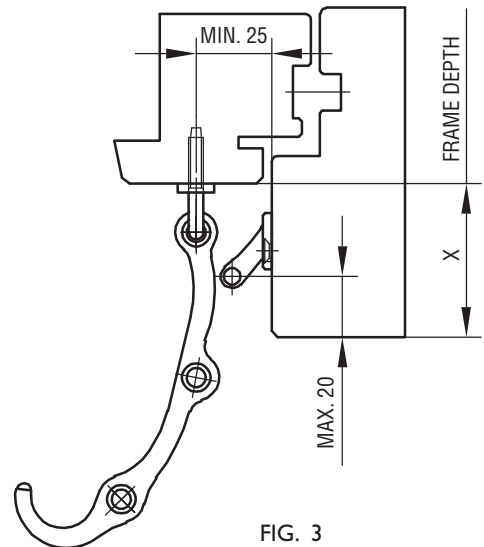

FIG. 3
IPA NO. 21379 WITH 21382

THE MENTIONED MAX. AND MIN. DIMENSIONS APPLY FOR A FRAME DEPTH (X ON THE DRAWING) OF AS MUCH AS 50 MM. IF X IS BIGGER THAN 50 MM, WE RECOMMEND USING IPA NO. 21371



CASEMENT FASTENERS

IPA NO.s 21383 - 96 & 21593-94

IPA NO.	MATERIAL		SURFACE							STANDARD PACKING IN BOXES OF 25 PIECES	STANDARD PACKING IN BOXES OF 50 PIECES	INDUSTRY PACKING IN BOXES OF 200 PIECES	INDUSTRY PACKING IN BOXES OF 500 PIECES	A MM	B MM	SCREW	EYE SCREW	APPROX. WEIGHT KG / 100 PICES
	STEEL	BRASS	WITHOUT SPECIFICATION	ELECTROPL.				POLISHED										
				WHITE	BROWN	ELECTROPLATED	YELLOW											
21383	1	-	0	-	-	21	25	-	-	-	-	2	24	50	3,5	M5 X 20	4,0	
21385	1	-	0	06	-	21	-	-	-	1	-	-	28	50	3,5	-	4,0	
	1	-	0	-	-	-	25	-	-	1	-	2						
21386	1	-	0	06	-	21	25	-	-	1	-	2	28	50	3,5	M5 X 15	5,0	
21388	1	-	0	06	-	-	-	-	-	1	-	-	21	50	3,5	-	4,0	
	1	-	0	-	-	21	25	-	-	1	-	2						
21389	1	-	0	06	-	-	25	-	-	1	-	-	24	50	3,5	-	4,6	
	1	-	0	-	-	21	-	-	-	1	-	2						
21390	1	-	0	-	-	21	25	-	-	-	-	2	24	50	3,5	-	3,8	
21391	1	-	0	-	12	-	-	-	-	1	-	-	28	50	3,5	-	4,0	
	1	-	0	06	-	21	25	-	-	1	-	2						
21392	1	-	0	-	-	21	25	-	1	-	-	-	28	50	3,5	-	4,4	
21393	1	-	0	-	12	-	-	-	-	1	-	-	28	50	3,5	M5 X 20	4,4	
	1	-	0	06	-	21	25	-	-	1	-	2						
21394	1	-	0	-	-	21	25	-	1	-	-	-	28	50	3,5	M5 X 20	5,0	
21396	1	-	0	06	-	21	25	-	-	-	-	2	24	50	3,5	M5 X 20	5,0	
21593	1	-	0	06	-	21	25	-	-	-	-	2	28	50	3,5	M5 X 20	4,4	
21594	1	-	0	-	-	21	25	-	1	-	-	-	24	50	3,5	M5 X 20	5,0	

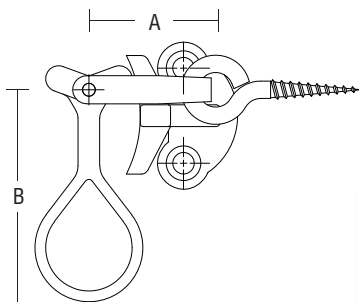

IPA no.s 21383-86



IPA no.s 21385



IPA no. 21388



IPA no. 21389



IPA no. 21390-91



IPA no. 21392



IPA no.s 21393+96+21593



IPA no.s 21394+21594



IPA NO.s 21383 - 96 + 21593-94 FITTINGS INSTRUCTIONS

CASEMENT HOOK
WITH EYE SCREW

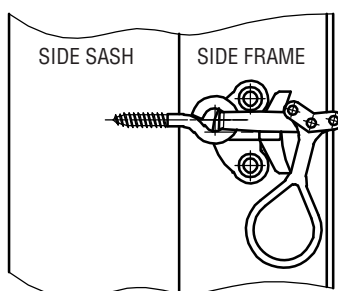

CASEMENT HOOK
WITH SCREW PLATE

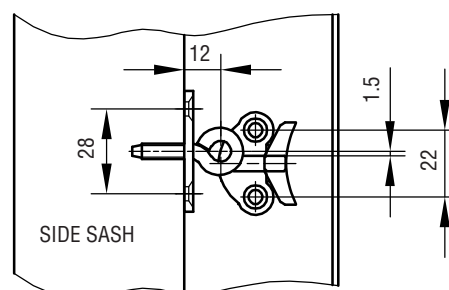
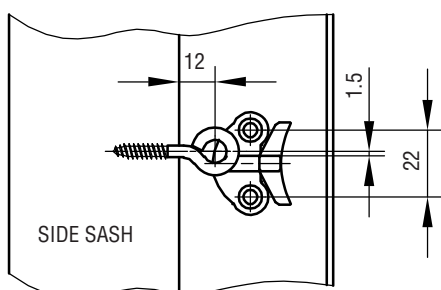
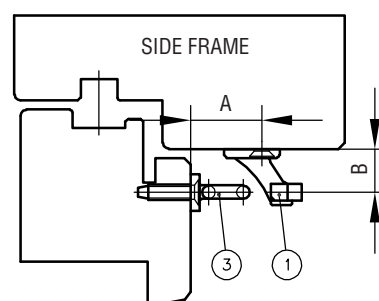
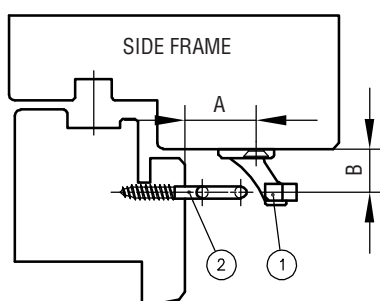
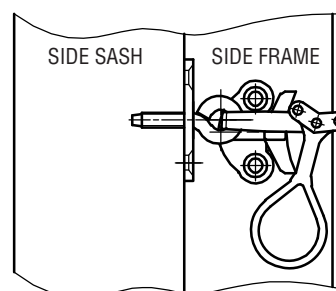

FIG. 1

IPA NO.s 21385 + 21388-92

FIG. 2

IPA NO.s 21383 + 21386 +
21393-96 + 21593-94

IPA NO.	21385 21391 - 92	21388	21389	21390	21383 + 96	21386 21393 - 94	21593 - 94
A MM	24	19	11	20	23	27	27
B MM	14	14	15	14	14	14	19

MONTERING:

1. MOUNT THE RECEIVER (1), ON SIDE FRAME IN THE WANTED HEIGHT.

2. IPA NR. 21385 + 21388-92: MEASURE PRECISELY ON THE SIDE SASH FOR THE CASEMENT HOOK WITH EYE SCREW (2).
PRE-DRILL A HOLE FOR THE EYE SCREW. FASTEN THE CASEMENT HOOK WITH EYE SCREW.

IPA NR. 21383 + 21386 +
21393-96 + 21593-94: MEASURE PRECISELY ON THE SIDE SASH FOR THE CASEMENT HOOK WITH SCREW PLATE (3).
PRE-DRILL A 5.0 MM HOLE FOR THE THREADED SCREW AND PRE-DRILL THE HOLES FOR THE EYE SCREWS. MARK UP FOR THE 2 SCREW HOLES ON THE SASH AND PRE-DRILL THE HOLES. FASTEN THE CASEMENT HOOK WITH SCREW PLATE.



HANDLES & RECEIVERS FOR WINDOW ESPAGNOLETTES



IPA NO. 23228-29+33-34
RIGHT

HANDLES

ORDERING NO.											
IPA NO.	MATERIAL		SURFACE		STANDARD PACKING IN BOXES OF 10 PCS.	PIN MM	DISTANCE BETWEEN SCREWHOLES MM	LENGTH OF PIN MM	HOLES FOR SCREWS MM	WEIGHT APPROX. KGS / EACH.	
	ALLOY	LEFT	RIGHT	DULL CROME							CROME
23228	0	7	8	80	-	1	8	42	43	5	0,15
23229	0	7	8	-	81	1	8	42	43	5	0,15
23233	0	7	8	80	-	1	7	42	43	5	0,15
23234	0	7	8	-	81	1	7	42	43	5	0,15



IPA NO. 23238

SAFETY LOCK

ORDERING NO.						
IPA NO.	MATERIAL		SURFACE		STANDARD PACKING IN BOXES OF 5 PCS.	HOLE MM
	STEEL	W/O SPECIFICATION	DULL CROME	CROME		
23238	1	0	80	81	1	8 X 8

FOR HANDLES 23228-29+33-34



IPA NO. 23269

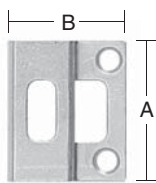

IPA NO. 23270

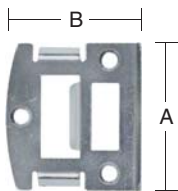

IPA NO. 63252

RECEIVERS

ORDERING NO.												
IPA NO.	MATERIAL			SURFACE			A MM	B MM	C MM	MATERIAL MM	SCREW	APPROX. WEIGHT KG/100 PCS.
	STEEL	STAINLESS STEEL	WITHOUT SPECIFICATION	ELECTROPLATED	UNMACHINED	STANDARD PACKING IN BOXES OF 20 PIECES						
23269	1	-	0	21	-	1	46	25	-	7,00	4,0	3,0
23270	-	8	0	-	86	1	46	38,5	18	1,75	4,0	2,6
63252	1	-	0	21	-	-	55	50	-	1,50	3,5	2,3



ESPAGNOLETTES

WITH SIDE BOLTS

IPA NO.s 23601-09 & IPA NO.s 23615-24

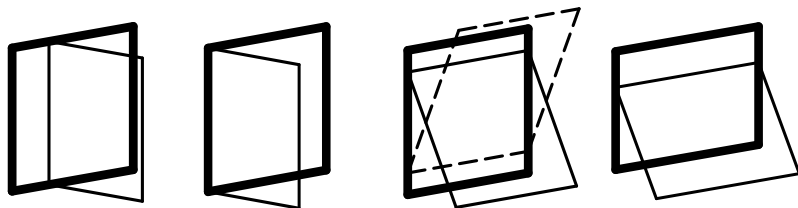

12 MM SIDE BOLTS

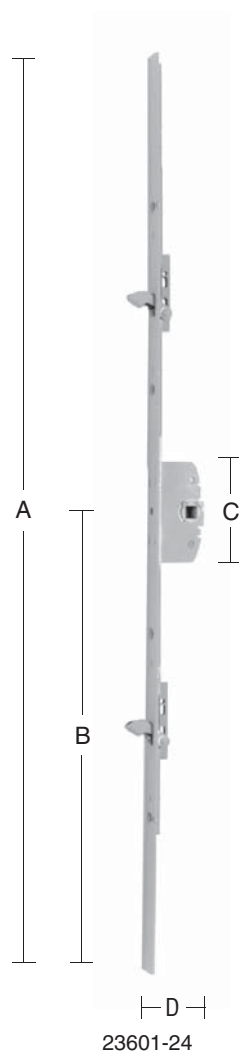

ORDERING NO.														
IPA NO.	MATERIAL	SURFACE		STANDARD PACKING IN BOXES OF 10 PIECES	A MM	B MM	BACKSET MM	PIN MM	C MM	D MM	FACEPLATE MM	THICKNESS PLATE MM	SCREW	APPROX. WEIGHT KG / EACH
	STEEL	SQUARE EDGES	ELECTROPLATED											
23601	1	6	21	1	600	300	25	8	66	34	16	2,5	4,0	0,30
23602	1	6	21	1	720	360	25	8	66	34	16	2,5	4,0	0,35
23603	1	6	21	1	820	410	25	8	66	34	16	2,5	4,0	0,40
23604	1	6	21	1	920	460	25	8	66	34	16	2,5	4,0	0,45
23605	1	6	21	1	1020	510	25	8	66	34	16	2,5	4,0	0,50
23606	1	6	21	1	1120	560	25	8	66	34	16	2,5	4,0	0,55
23607	1	6	21	1	1220	610	25	8	66	34	16	2,5	4,0	0,60
23608	1	6	21	1	1320	660	25	8	66	34	16	2,5	4,0	0,65
23609	1	6	21	1	1420	710	25	8	66	34	16	2,5	4,0	0,70
23615	1	6	21	1	600	300	28	8	66	37	16	2,5	4,0	0,30
23616	1	6	21	1	720	360	28	8	66	37	16	2,5	4,0	0,35
23617	1	6	21	1	820	410	28	8	66	37	16	2,5	4,0	0,40
23618	1	6	21	1	920	460	28	8	66	37	16	2,5	4,0	0,45
23619	1	6	21	1	1020	510	28	8	66	37	16	2,5	4,0	0,50
23620	1	6	21	1	1120	560	28	8	66	37	16	2,5	4,0	0,55
23621	1	6	21	1	1220	610	28	8	66	37	16	2,5	4,0	0,60
23622	1	6	21	1	1320	660	28	8	66	37	16	2,5	4,0	0,65
23623	1	6	21	1	1420	710	28	8	66	37	16	2,5	4,0	0,70
23624	1	6	21	1	1400	700	28	8	66	37	16	2,5	4,0	0,75

- CONSEALED FITTINGS
- IMPROVED SECURITY IN CLOSED POSITION
- USABLE FOR TOP HUNG WINDOWS ALSO



ESPAGNOLETTES

WITHOUT MUSHROOM HEAD BOLTS

IPA nr. 63021-30 + 63041-50

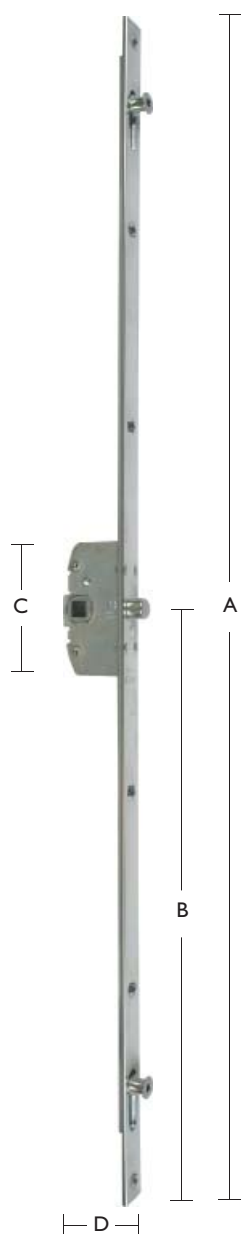
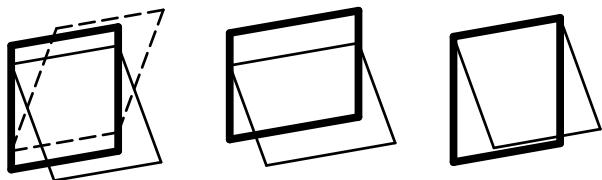

ORDERING NO.														
IPA NO.	MATERIAL	SQUARE EDGES	SURFACE	INDUSTRY PACKING IN BOXES OF 25 PCS.	A MM	B MM	BACKSET MM	FOR PIN MM	C MM	D MM	FACEPLATE MM	THICKNESS PLATE MM	SCREW	WEIGHT APPROX. KGS / 100 PIECES
	STEEL		ELECTROPLATED											
63021	1	6	21	2	300	150	28	8	66	37	16	2,5	4,0	0,20
63022	1	6	21	2	400	200	28	8	66	37	16	2,5	4,0	0,24
63024	1	6	21	2	600	300	28	8	66	37	16	2,5	4,0	0,34
63026	1	6	21	2	800	400	28	8	66	37	16	2,5	4,0	0,44
63028	1	6	21	2	1000	500	28	8	66	37	16	2,5	4,0	0,54
63030	1	6	21	2	1200	600	28	8	66	37	16	2,5	4,0	0,64
63041	1	6	21	2	300	150	25	8	66	34	16	2,5	4,0	0,20
63042	1	6	21	2	400	200	25	8	66	34	16	2,5	4,0	0,24
63044	1	6	21	2	600	300	25	8	66	34	16	2,5	4,0	0,34
63046	1	6	21	2	800	400	25	8	66	34	16	2,5	4,0	0,44
63048	1	6	21	2	1000	500	25	8	66	34	16	2,5	4,0	0,54
63050	1	6	21	2	1200	600	25	8	66	34	16	2,5	4,0	0,64



IPA NO.s 63021-30 & 63041-50 FITTINGS INSTRUCTIONS

IPA NO.	L MM	A MM	B MM BACKSET
63021	300	195	28
63022	400	295	
63024	600	495	
63026	800	695	
63028	1000	895	
63030	1200	1095	
63041	300	195	25
63042	400	295	
63044	600	495	
63046	800	695	
63048	1000	895	
63050	1200	1095	

FIG. 1

FIG. 2
SHOWN WITH RECEIVER IPA NO. 23190

FIG. 3

USE SCREW NO. 4.0.

MAINTENANCE:

THE FITTINGS ARE NOT TO BE PAINTED. TEST THE OPERATION FROM TIME TO TIME. WHEN MOUNTING - LUBRICATE THE PIVOT/MOVABLE METAL PARTS OF THE MECHANISM WHILE ACTIVATING REPEATEDLY. HEREAFTER LUBRICATE MINIMUM TWICE A YEAR. SEE ALSO INSTRUCTIONS ON PAGE 41 - 42

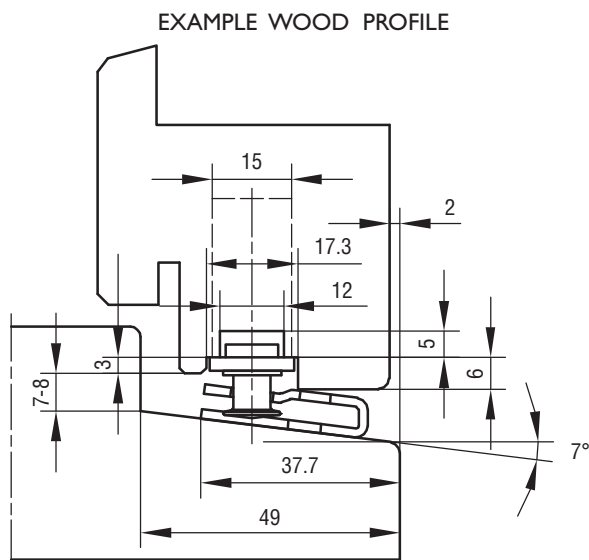
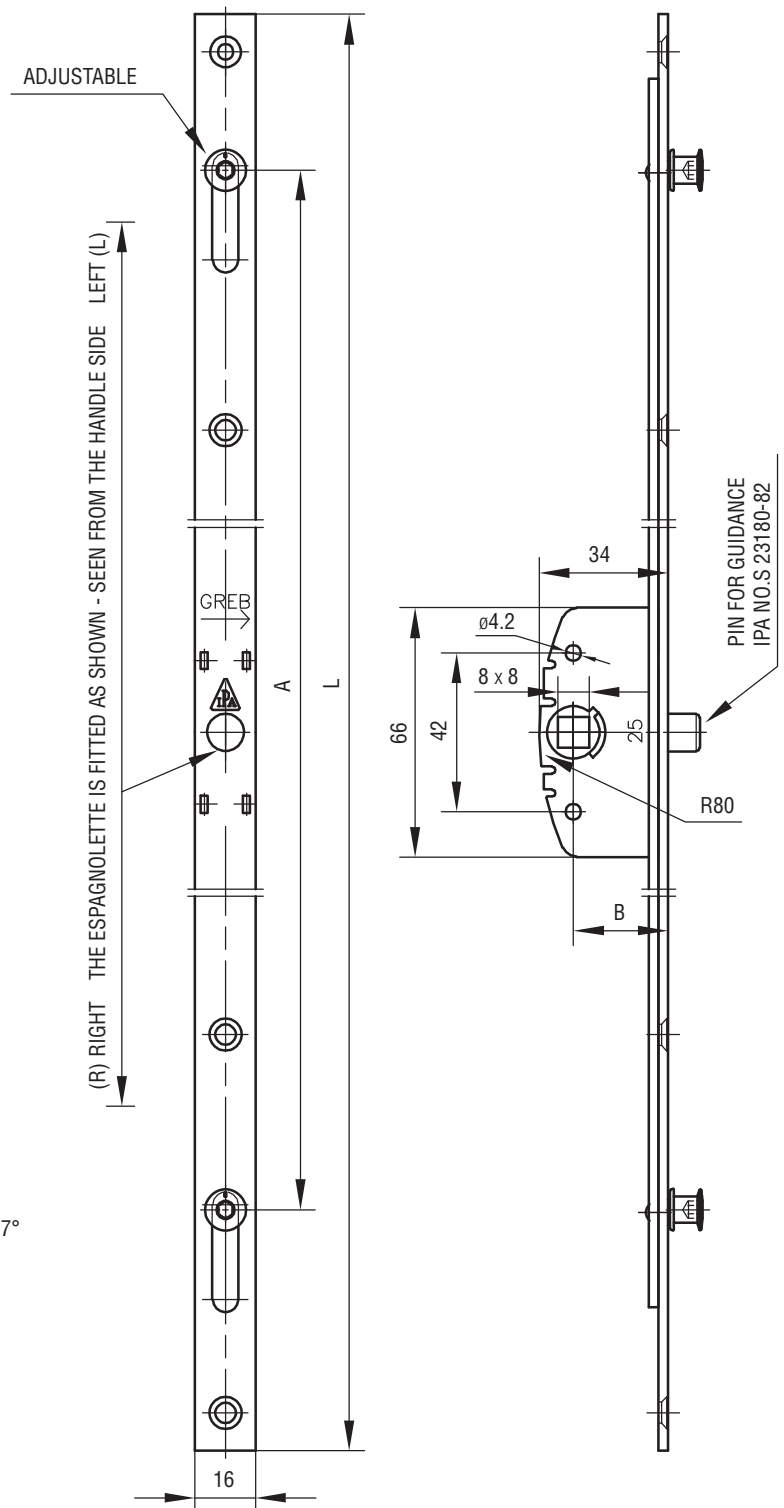

ESPAGNOLETES

WITHOUT MUSHROOM HEAD BOLTS

IPA nr. 63051-60 + 63081 + 23190

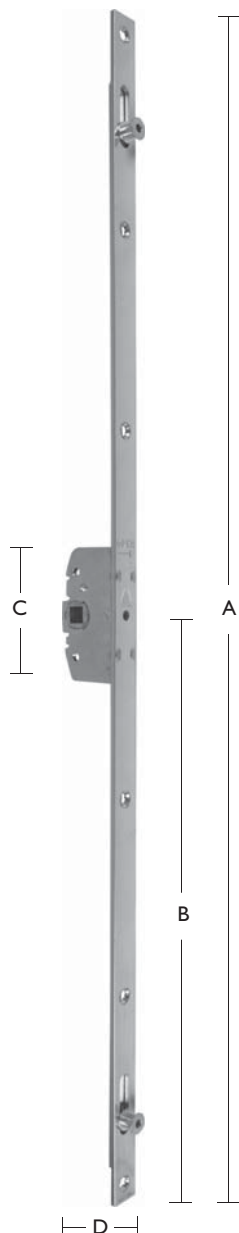
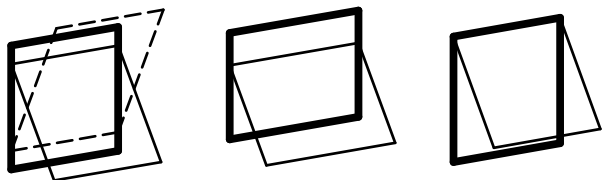

ORDERING NO.														
IPA NO.	MATERIAL	SURFACE			A MM	B MM	BACKSET MM	FOR PIN MM	C MM	D MM	FACEPLATE MM	THICKNESS PLATE MM	SCREW	WEIGHT APPROX. KGS / 100 PIECES
	STEEL	SQUARE EDGES	ELECTROPLATED	INDUSTRY PACKING IN BOXES OF 25 PCS.										
63051	1	6	21	2	300	150	25	8	66	34	16	2,5	4,0	0,20
63052	1	6	21	2	400	200	25	8	66	34	16	2,5	4,0	0,24
63054	1	6	21	2	600	300	25	8	66	34	16	2,5	4,0	0,34
63056	1	6	21	2	800	400	25	8	66	34	16	2,5	4,0	0,44
63058	1	6	21	2	1000	500	25	8	66	34	16	2,5	4,0	0,54
63060	1	6	21	2	1200	600	25	8	66	34	16	2,5	4,0	0,64

GUIDE PIN



ORDERING NO.								
IPA NR.	MATERIAL	SURFACE		INDUSTRY PACKING IN BOXES OF 100 PCS.	A MM	B MM	SCREW	APPROX. WEIGHT KG / EACH
	PLASTIC	W/O SPECIFICATION	BLACK					
63081	9	0	57	2	8	8,3	4,0	0,05

USED TOGETHER WITH ESPAGNOLETES WITH MUSHROOM HEAD BOLTS W/O GUIDE PIN IPA NO. 63051-60

RECEIVER

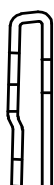
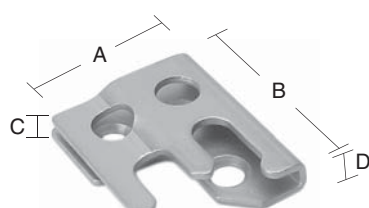

ORDERING NO.											
IPA NO.	MATERIAL	SURFACE			A MM	B MM	C MM	D MM	SCREW	WEIGHT APPROX. KG / 100 PIECES	
	STAINLESS STEEL	W/O SPECIFICATION	UNMACHINED	STANDARD PACKING IN BOXES OF 25 PIECES							INDUSTRY PACKING IN BOXES OF 100 PIECES
23190	8	0	86	1	2	32,5	40	7	8	4,0	0,024



IPA NO.s 63051-60 + 63081 FITTINGS INSTRUCTIONS

IPA NO.	L MM	A MM
63051	300	195
63052	400	295
63054	600	495
63056	800	695
63058	1000	895
63060	1200	1095

FIG. 1

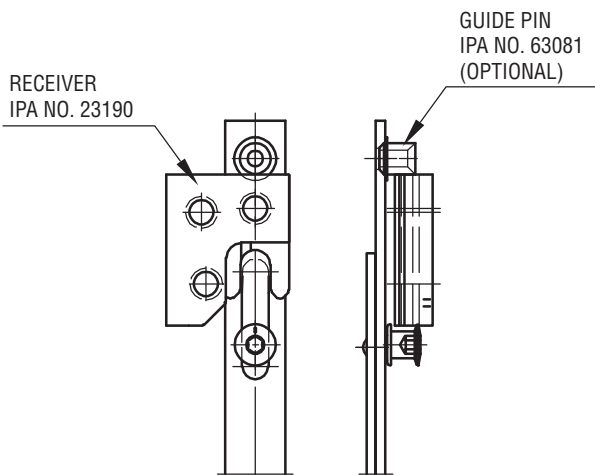

FIG. 4

WHEN USING IPA GUIDE PIN NO. 63081, THE PIN MUST BE PLACED IN THE SCREWHOLE JUST TO THE RIGHT SIDE OF THE RIGHT LOCKING POINT (SEEN FROM THE OUTSIDE)

EXAMPLE WOOD PROFILE

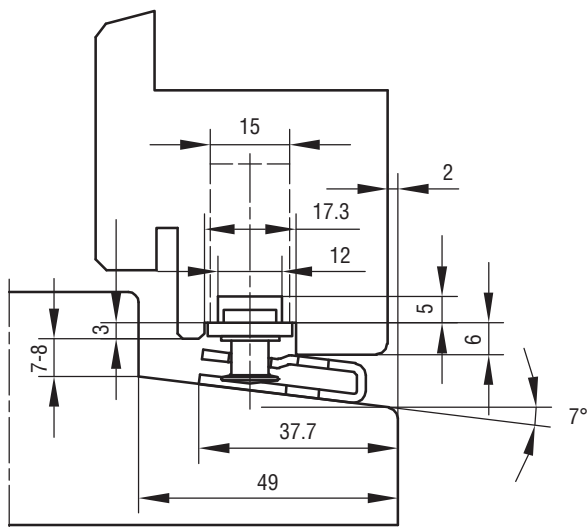

FIG. 2

SHOWN WITH RECEIVER IPA NO. 23190

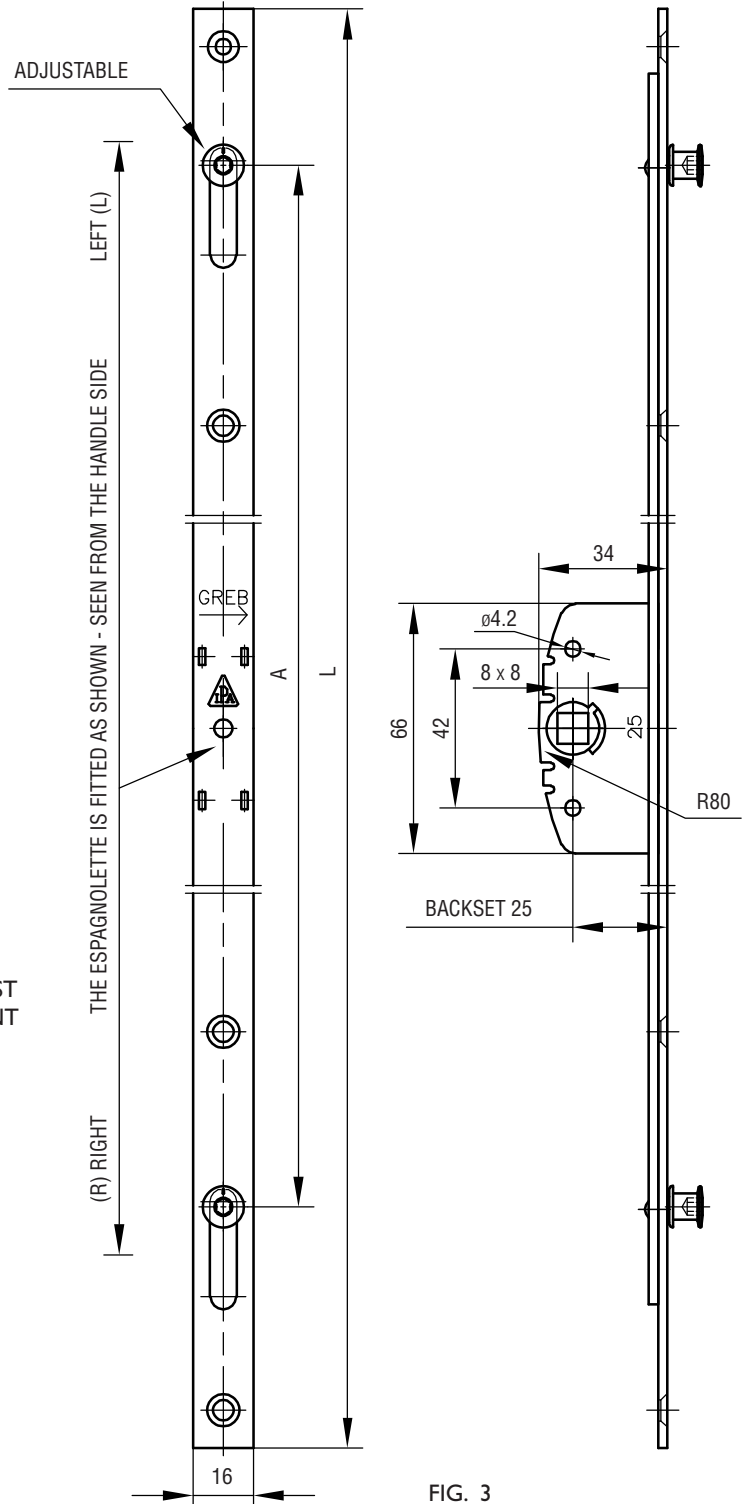

FIG. 3

USE SCREW NO. 4.0.

MAINTENANCE:

TEST THE OPERATION FROM TIME TO TIME. WHEN MOUNTING - LUBRICATE THE PIVOT/MOVABLE METAL PARTS OF THE MECHANISM WHILE ACTIVATING REPEATEDLY. HERAFTER LUBRICATE MINIMUM TWICE A YEAR. SEE ALSO INSTRUCTIONS ON PAGE 41 - 42.



MAINTENANCE LUBRICATION INSTRUCTIONS

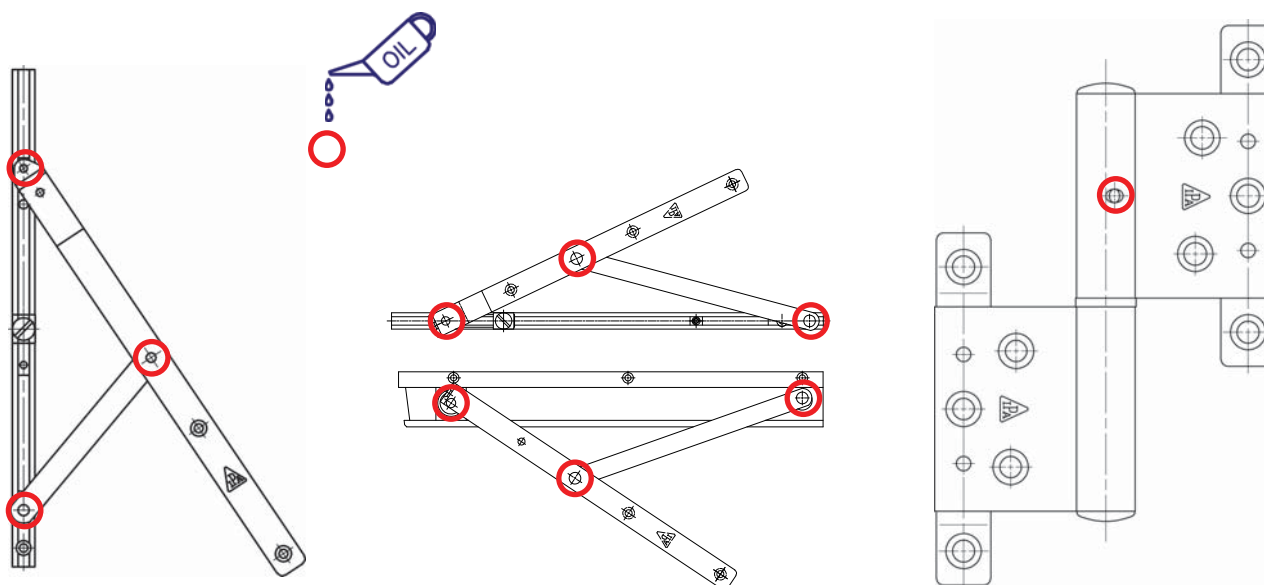

GENERALLY all parts of a building have to be looked after and maintained from time to time. This of course also applies for fittings in windows and doors.

How often fittings in windows and doors should be maintained depends to a large extent on how they are used, how often they are operated, and not least on the environment the fittings are exposed to.

Corrosion may also be caused by other factors, such as corrosive liquids, air pollution etc. Special attention should be given to fittings used in windows and doors in urban and industrial areas or other areas with a high traffic intensity as well as coastal areas. Fittings in such environments should be checked and greased more often than fittings used in areas with less corrosive effects.

HINGES AND FITTINGS should be lubricated when necessary, or at the minimum twice a year.

SLIDING ELEMENTS AS WELL AS ALL ALURAILS with sliding surfaces are to be kept clean and free from dust and dirt to ensure a smooth sliding function. Stearin wax or a clean lubricating film (but no oil and no grease!) can be applied onto the aluminium rails.

ESPAGNOLETTES AND OTHER LOCKING FITTINGS should be greased or lubricated with acid free grease or acid free oil on spray. The grease/oil should be applied into the mechanism box as well as on the joints of the side bolts, the roller bolts, or the mushroom head bolts while activating the mechanism repeatedly. Grease or lubricate when necessary or at the minimum twice a year.

Continues.....



MAINTENANCE LUBRICATION INSTRUCTIONS

BRASS will sooner or later get some discoloration in a brownish tone depending on the environment in which it is placed. The original brass surface can be maintained by polishing from time to time.

STAINLESS STEEL can get some discoloration, although this rarely happens. Different chemical influences like acid fumes, contamination from wood preservation treatments, or air pollution may cause discoloration of the metal, sometimes to a reddish tone which could look like rust. Thin discoloration can be removed just by using common cleaner or polish.

PAINTED FITTINGS will from time to time need repainting. Before painting all parts should be cleaned carefully. When choosing type of paint and when applying the paint remember to follow the instructions from the paint manufacturer very carefully.

When painting a wooden window in a house, it is a good idea also to paint the visible parts of the fittings (please note: No alurails nor sliding parts should ever be painted!). The painting of the fitting will minimize corrosion and add to the lifetime of the fitting. Always make sure that the proper function of a fitting is not affected by the painting.

ANODIZED ALUMINIUM should be cleaned from time to time, depending on the surroundings in which it is placed. Cleaning of the surface with a cloth or sponge is recommended. Eventually a neutral solvent can be used. Emery cloth, steel wool, sodium carbonate, and other cleansers or abrasives containing alkalies or acid should never be used.

ON THE WINDOW AND DOOR FACTORY SITE all fittings should be lubricated or greased before shipment. Hinges should be lubricated with acidfree oil while activating repeatedly, an acidfree grease can also be used. When using grease it should be applied directly onto the pin of the hinges. It may be necessary to dismantle the sash before greasing. Especially hinges with a brass pin should be greased.

When mounting fittings, please make sure that the tools do not damage the original surface treatment. When original surface has been damaged make sure that remedial take place as soon as possible.

**WHEN IN DOUBT PLEASE CONTACT YOUR LOCAL SUPPLIER OR A/S J. PETERSENS
BESLAGFABRIK.**



A/S J. PETERSENS BESLAGFABRIK

JACOB PETERSENSVEJ 9, DK-9240 NIBE
www.ipafittings.com

TEL.: (+45) 98 35 15 00
ipa@ipafittings.com